

ALTO SHAAM®

ELECTRIC FRYER



*Basic Control
shown with optional
automatic basket lifts*



*Deluxe Control
shown with optional
automatic basket lifts*



**MODEL
ASF-75E**

**BASIC CONTROL
OR
DELUXE CONTROL**

- **INSTALLATION**
- **OPERATION**
- **MAINTENANCE**



W164 N9221 Water Street • P.O. Box 450 • Menomonee Falls, Wisconsin 53052-0450 USA

PHONE: 262.251.3800 • 800.558.8744 USA/CANADA

FAX: 262.251.7067 • 800.329.8744 U.S.A. ONLY

WEBSITE: www.alto-shaam.com

ASF-75E FRYER OPERATION MANUAL INDEX

Delivery, Unpacking	1	
Safety Procedures	2	
Specifications, Accessories, Options, Weight	3	
LOCATION SITE & INSTALLATION REQUIREMENTS		
Site & Clearance Requirements	4	
Ventilation	6	
Restraint Requirements	7	
Electrical Requirements	8	
Oil/Shortening Requirements	10	
BASIC CONTROL		
Basic Control - Panel Identification	11	
Start Up & General Operation	12	
Boil-Out	13	
Left & Right Basket Operation	14	
Synchronized Baskets Option	16	
Basic Control - Programming Overview	17	
Basic Control - Programming the Control	18	
Temperature Verification	20	
CARE AND CLEANING		
Cleaning & Maintenance	21	
OPERATING INSTRUCTIONS		
Suggested Frying Times	23	
DELUXE CONTROL		
Deluxe Control Panel Identification	24	
Start Up & General Operation	25	
Boil-Out	26	
Deluxe Control - Programmed Product Key Operation	28	
Deluxe Control - Manual Operation	30	
Deluxe Control - Programming Overview	32	
Deluxe Control - Programming the Control	33	
Temperature Verification	45	
Control Troubleshooting	45	
Oil/shortening Filtration	47	
Filter Replacement	48	
Filter Cleaning & Maintenance	49	
Cleaning & Maintenance - Nozzle	50	
SERVICE		51
Parts List	56	
Wiring Diagrams	59	
FRYPOT WARRANTY		67
TRANSPORTATION DAMAGE & CLAIMS		68
LIMITED WARRANTY		68

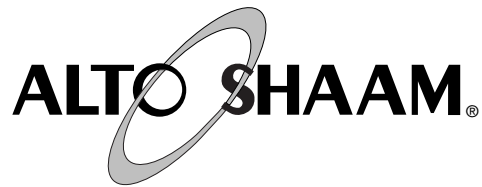

DELIVERY

This Alto-Shaam appliance has been thoroughly tested and inspected to insure only the highest quality unit is provided. Upon receipt, check for any possible shipping damage and report it at once to the delivering carrier. *See Transportation Damage and Claims section located in this manual.*

This appliance, complete with unattached items and accessories, may have been delivered in one or more packages. Check to ensure that all standard items and options have been received with each model as ordered.

Save all the information and instructions packed with the appliance. Complete and return the warranty card to the factory as soon as possible to assure prompt service in the event of a warranty parts and labor claim.

This manual must be read and understood by all people using or installing the equipment model. Contact the Alto-Shaam service department if you have any questions concerning installation, operation, or maintenance.

NOTE: All claims for warranty must include the full model number and serial number of the unit.

UNPACKING

1. Carefully remove the appliance from the carton or crate.

NOTE: Do not discard the carton and other packaging material until you have inspected the unit for hidden damage and tested it for proper operation.

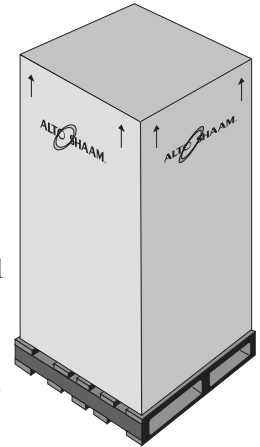

2. Read all instructions in this manual carefully before initiating the installation of this appliance.

DO NOT DISCARD THIS MANUAL.

This manual is considered to be part of the appliance and is to be provided to the owner or manager of the business or to the person responsible for training operators. *Additional manuals are available from the Alto-Shaam service department.*

3. Remove all protective plastic film, packaging materials, and accessories from the appliance before connecting electrical power. Store any accessories in a convenient place for future use.

SAFETY PROCEDURES AND PRECAUTIONS

Knowledge of proper procedures is essential to the safe operation of electrically and/or gas energized equipment. In accordance with generally accepted product safety labeling guidelines for potential hazards, the following signal words and symbols may be used throughout this manual.

DANGER	
	Used to indicate the presence of a hazard that WILL cause severe personal injury, death, or substantial property damage if the warning included with this symbol is ignored.

WARNING	
	Used to indicate the presence of a hazard that CAN cause personal injury, possible death, or major property damage if the warning included with this symbol is ignored.

CAUTION	
	Used to indicate the presence of a hazard that can or will cause minor or moderate personal injury or property damage if the warning included with this symbol is ignored.

CAUTION	
Used to indicate the presence of a hazard that can or will cause minor personal injury, property damage, or a potential unsafe practice if the warning included with this symbol is ignored.	

NOTE: Used to notify personnel of installation, operation, or maintenance information that is important but not hazard related.

1. This appliance is intended to cook, hold or process foods for the purpose of human consumption. No other use for this appliance is authorized or recommended.
2. This appliance is intended for use in commercial establishments where all operators are familiar with the purpose, limitations, and associated hazards of this appliance. Operating instructions and warnings must be read and understood by all operators and users.
3. Any troubleshooting guides, component views, and parts lists included in this manual are for general reference only and are intended for use by qualified technical personnel.
4. This manual should be considered a permanent part of this appliance. This manual and all supplied instructions, diagrams, schematics, parts lists, notices, and labels must remain with the appliance if the item is sold or moved to another location.

NOTE	
	For equipment delivered for use in any location regulated by the following directive: DO NOT DISPOSE OF ELECTRICAL OR ELECTRONIC EQUIPMENT WITH OTHER MUNICIPAL WASTE.

SPECIFICATIONS

DIMENSIONS EXTERIOR	
HEIGHT:	44-1/2" (1130mm)
WIDTH:	24-13/16" (630mm)
DEPTH:	37-7/8" (961mm)
BASKET DIMENSIONS (H X W X D)	
11-1/2" x 12-3/4" x 21-3/4" (292mm x 324mm x 552mm)	

CAPACITY
SHORTENING/OIL: 73 lb (33 kg) MAXIMUM

WEIGHT EST.	NET WEIGHT	SHIP WEIGHT
	338 lb (154 kg)	460 lb (209 kg)
CARTON DIMENSIONS		
(H x W x D): 50" x 31" x 43" (1270mm x 787mm x 1092mm)		

STANDARD ACCESSORIES	
<input type="checkbox"/> Basket, Half-Size (2 INCLUDED AS STANDARD)	BS-27140
Brush Set (ONE 3-BRUSH SET INCLUDED AS STANDARD)	
<input type="checkbox"/> ANGLE BRUSH	BH-27382
<input type="checkbox"/> SCRUB BRUSH	CE-27122
<input type="checkbox"/> STRAIGHT BRUSH	BH-27121
Filter, Paper (7 PAPER FILTERS INCLUDED AS STANDARD)	
<input type="checkbox"/> 7 COUNT REFILL PACKAGE	FI-27791
<input type="checkbox"/> 100 COUNT REFILL PACKAGE	FI-27794



OPTIONS	
<input type="checkbox"/> Basket, Full-Size	BS-26998
FILTERS	
<input type="checkbox"/> Charcoal/Carbon (30 COUNT PKG.)	FI-27648
<input type="checkbox"/> Reusable Mesh (SINGLE FILTER)	FI-27014
<input type="checkbox"/> Fry Pot Cover	5005136
<input type="checkbox"/> Mobile Drawer Cover	5006073
<input type="checkbox"/> Strainer/Skimmer	CE-27400
<input type="checkbox"/> Oil Discard Hose	HO-27686

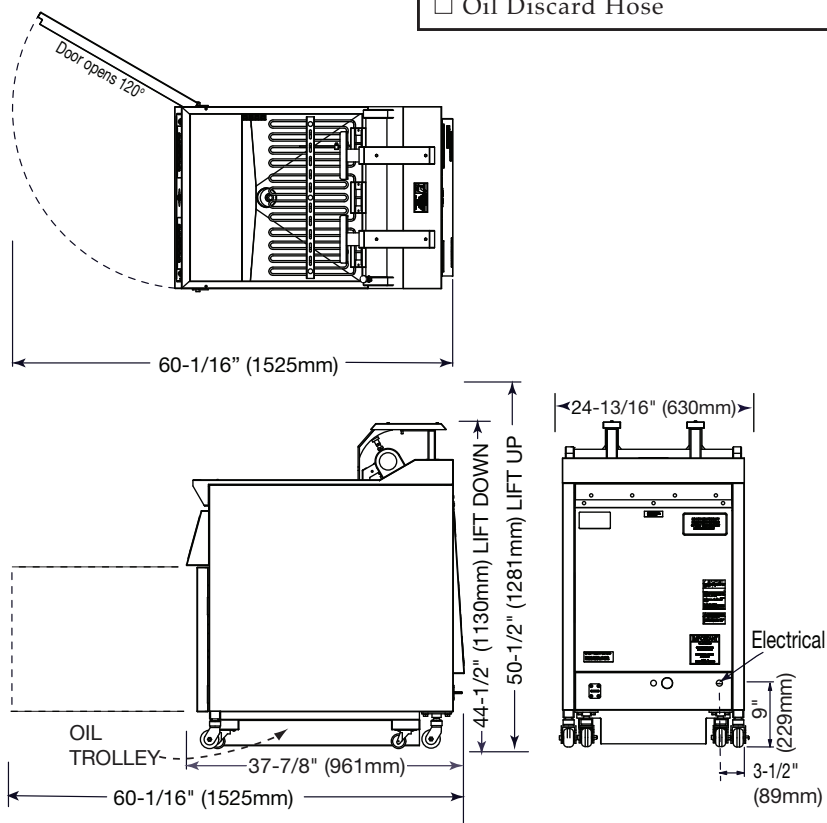

INSTALLATION



DANGER

IMPROPER INSTALLATION, ADJUSTMENT, ALTERATIONS, SERVICE, OR MAINTENANCE CAN CAUSE PROPERTY DAMAGE, INJURY OR DEATH.

READ THE INSTALLATION, OPERATING AND MAINTENANCE INSTRUCTIONS THOROUGHLY BEFORE INSTALLING OR SERVICING THIS EQUIPMENT.



DANGER

AVERTISSEMENT: UNE INSTALLATION, UN ADJUSTEMENT, UNE ALTERATION, UN SERVICE OU UN ENTRETIEN NON CONFORME AUX NORMES PEUT CAUSER DES DOMMAGES A LA PROPRIETE, DES BLESSURES OU LA MORT.

LIRE ATTENTIVEMENT LES DIRECTIVES D'OPERATION ET D'ENTRETIEN AVANT DE FAIRE L'INSTALLATION, OU L'ENTRETIEN DE CET EQUIPEMENT.



CAUTION

DO NOT USE FORKLIFT FROM FRONT OR REAR OF UNIT. USE FORKLIFT FROM SIDE ONLY.

NOTE: To avoid equipment damage, remove the Mobile Oil Trolley before moving this appliance with a forklift or pallet lift.

MINIMUM CLEARANCE REQUIREMENTS

	COMBUSTIBLE SURFACES	NON-COMBUSTIBLE SURFACES
RIGHT SIDE	6" (152mm)	0" (0mm)
LEFT SIDE	6" (152mm)	0" (0mm)
BACK	6" (152mm)	6" (152mm)
FRONT	25" (635mm)	

PLUS: 6" (152mm) minimum between the element swing in the extended position and the lower edge of the exhaust hood and filter media.

ENTRY CLEARANCE: 30" (762mm) uncrated

Ne pas installer à une distance inférieure à celle indiquée ce-dessous d'une paroi en matière combustible: Côtés 6 pouces, Arrière 6 pouces.

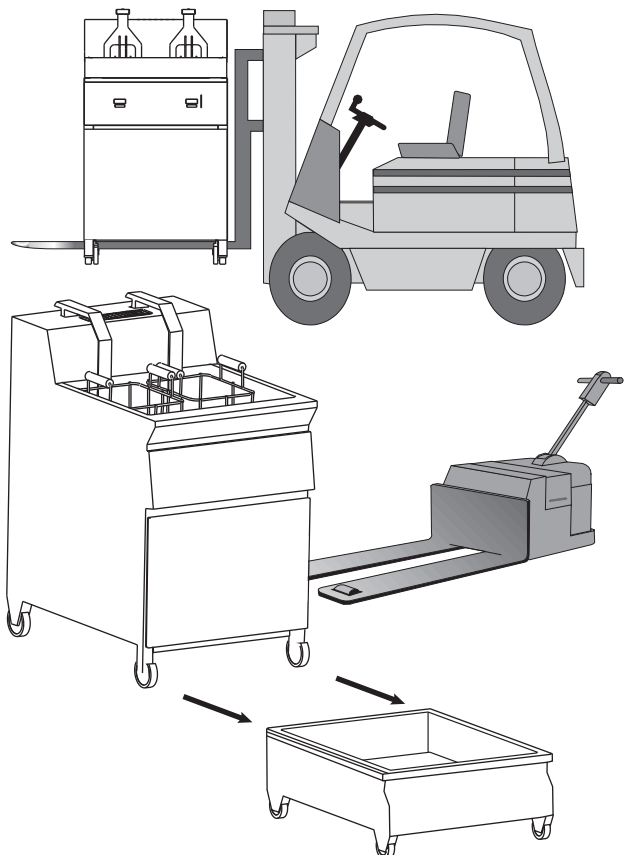

WARNING

MINIMUM CLEARANCES MUST REMAIN UNOBSTRUCTED. DO NOT place insulation or any other type of materials in clearance areas.

INSTALLATION

1. It is the responsibility of the installer to verify that this fryer installation is in compliance with the specifications listed in this manual and with local code requirements.
2. Hood installation is required.
3. Both cooking and cleaning functions require unobstructed access. The frypot, control panel, and front access door must be maintained free from obstruction. The access door must be accessible for service and maintenance.
4. Locate the fryer on a firm, level surface **ONLY**. The area surrounding the fryer must be kept clear of all combustible materials.
5. **FOR YOUR SAFETY DO NOT** store or use any flammable liquids or allow flammable vapors in the vicinity of this fryer or any other appliance.
6. **FOR YOUR SAFETY DO NOT** place insulation or any other type of materials in clearance areas.
7. When properly installed, the electric fryer is designed for operation adjacent to non-combustible floors and walls with a 6" clearance at the back. Clearances from all combustible construction is a minimum of 6" (152mm) at the back and both sides. Concrete, tile, terrazzo, or metal surfaces are recommended. Metal over a combustible material may not meet code for non-combustible surfaces. Verify site selection with local codes for specific requirements.
Doit être utilisé seulement sur des planchers non inflammables.
8. Adequate means must be provided to limit the movement of this appliance. A restraining device is required for field installation.
9. DO NOT install this fryer in any area where it

may be affected by any adverse conditions such as steam or dripping water, etc. DO NOT install the fryer over a drain.

10. **LEVELING:** Make certain the fryer is positioned firmly on all four supporting casters. Level fryer front-to-back and side-to-side by loosening the jam nut on each leveling caster and turning the caster. Restraining ties can be used for stabilization if necessary.

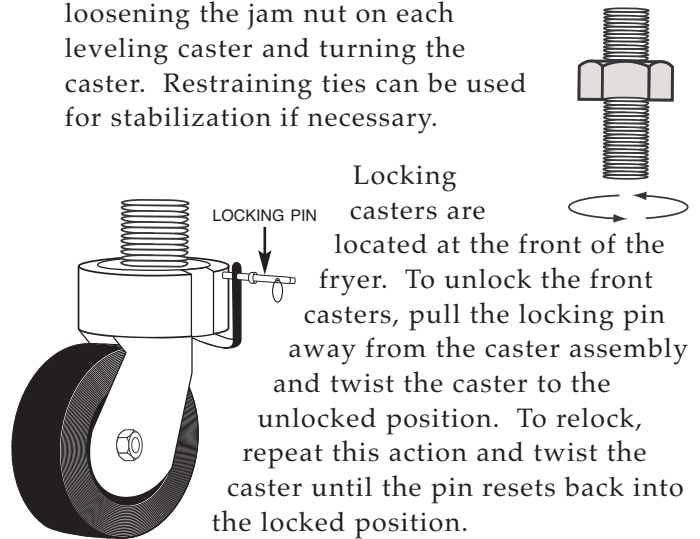

! WARNING

BURN WARNING: Make certain the fryer is stabilized before operation to prevent any movement or tipping and the possibility of severe burns caused by hot, splashing shortening or oil.

CAUTION

TO PREVENT PERSONAL INJURY, USE CAUTION WHEN MOVING OR LEVELING THIS APPLIANCE.

! WARNING

RISK OF ELECTRIC SHOCK.
Appliance must be secured to building structure.

! WARNING

Fire may be the result of improper installation. Carefully read and follow all installation instructions located in this manual.

INSTALLATION

VENTILATION:



DANGER

INSTALLATION, AIR VENTILATION REQUIREMENTS,
AND SERVICE WORK MUST BE IN ACCORDANCE
WITH ALL LOCAL CODES AND MUST BE PERFORMED
BY A QUALIFIED SERVICE TECHNICIAN.

An adequate ventilation system is required for commercial cooking equipment. Information may be obtained by writing to the National Fire Protection Association, Batterymarch Park, Quincy, MA 02269. When writing refer to NFPA No. 96.

Where automatically operated appliances are vented through a ventilating hood or exhaust system equipped with a damper or with a power means of exhaust, provisions shall be made to allow the equipment to operate only when the damper is open to a position to properly vent the appliance and when the power means of exhaust is in operation.

IN ACCORDANCE WITH NFPA 54 COMMONWEALTH OF MASSACHUSETTS ONLY.

RESTRAINT REQUIREMENTS — MOBILE EQUIPMENT

The fryer must be supplied with a connector that complies with all state and local installation codes.

Any appliance that is not furnished with a power supply cord but that includes a set of casters must be provided with a tether. Adequate means must be provided to limit the movement of this appliance without depending on or transmitting stress to the electrical conduit. The following requirements apply:

1. Casters must be a maximum height of 4-inches (102mm).
2. Such mobile appliances must be installed with the use of a flexible connector secured to the building structure.

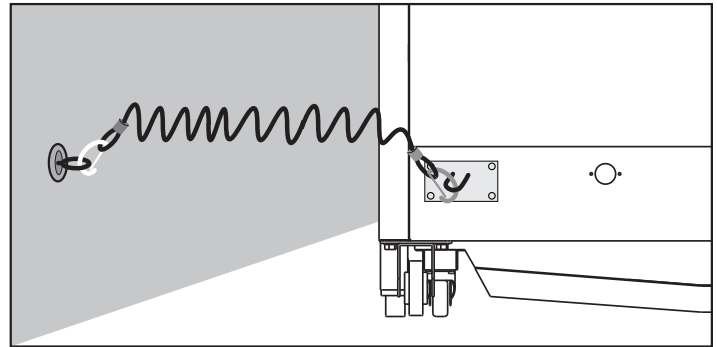

A mounting connector for a restraining device is located on the lower back flange of the appliance chassis, approximately 7-inches (178mm) from the floor. A flexible connector is not supplied by nor is it available from the factory.



ELECTRICAL REQUIREMENTS



! DANGER

To avoid electrical shock, this appliance **MUST** be adequately grounded in accordance with local electrical codes or, in the absence of local codes, with the current edition of the National Electrical Code ANSI/NFPA No. 70. In Canada, all electrical connections are to be made in accordance with CSA C22.1, Canadian Electrical Code Part 1 or local codes.

An electrical wiring diagram is located in the front access door of the fryer. The fryer must be installed by a qualified electrician. This appliance must be branch circuit protected with proper ampacities, in accordance with the wiring diagram located in the fryer. The fryer must be properly grounded in accordance with the National Electrical Code and applicable local codes.

Wire size for the main incoming power to the unit must match the minimum size listed in the specifications applicable to the specific fryer. For supply connections, locate the wire size posted on the label located on the electrical control box cover, behind the service panel or elsewhere listed in this manual.



! DANGER

ENSURE POWER SOURCE MATCHES VOLTAGE STAMPED ON APPLIANCE NAMEPLATE

Before operating the fryer, check all cable connections in the electrical connection area for tightness since connections can loosen during transport.

ELECTRICAL						
	VOLTAGE	PHASE	CYCLE/HZ	AMPS	kW	AWG
208-220V	at 208	3	60	66.6 (MAX.)	24.0	AWG 2
	at 220	3	60	70.8 (MAX.)	27.0	AWG 2
240V	240	3	60	61.5 (MAX.)	25.5	AWG 2
380-415V	at 380	3	50	35.1 (MAX.)	23.1	AWG 6
	at 415	3	50	38.1 (MAX.)	27.45	AWG 6
440-480V	at 440	3	60	30.6 (MAX.)	23.4	AWG 8
	at 480	3	60	33.3 (MAX.)	27.75	AWG 8

INSTALLATION

1. Refer to the nameplate on the FRONT of the fryer. Verify the electrical service power. Voltage and phase must match the nameplate specifications and available electrical service amperage must meet or exceed the specifications listed.

NOTE: Wire gauge, insulation type and temperature rating, as well as type, size and construction of conduit, must meet or exceed applicable specifications of local codes and of the National Electrical Code.

Warning!
440-480V - 3 Phase Only
The pump motor should *rotate counterclockwise*
when viewed from the rear of the fryer.
To change rotation, swap any two lines of 3 Phase incoming power.

6. The fryer is shipped from the factory wired for 3-phase electrical service. *This fryer is not approved for conversion to single phase. Converting to single phase will void the warranty and invalidate the ETL certification.*

IMPORTANT: Field wiring must be routed and secured away from the frypot, tubing, and filter pump and motor. Field wiring must allow access to the rear of the fryer for cleaning and for access to the oil filter pump motor reset button.

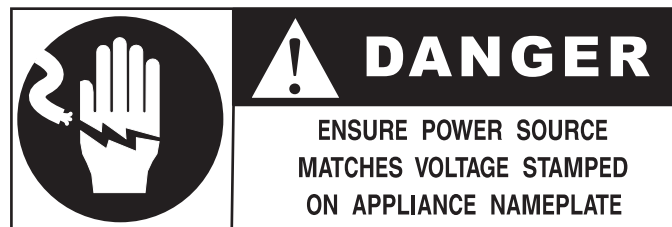

OPERATING INSTRUCTIONS

OIL/SHORTENING REQUIREMENTS

The fryer requires 73-pounds (33 kg) of oil or shortening in the frypot. Use only quality, high-grade oil/shortening in the fryer. The high moisture content of many lower grade shortening will result in excessive foaming and boil over. The cold oil/shortening level requirement for the fryer is indicated below.

CAUTION

COLD OIL or SHORTENING EXPANDS AS THE TEMPERATURE INCREASES. TO AVOID INJURY AND EQUIPMENT DAMAGE ALLOW FOR EXPANSION BY FILLING 1/2" (13mm) BELOW THE MAXIMUM HOT OIL FILL LINE.

NOTE: ALWAYS maintain the proper level of shortening by adding fresh oil/shortening to the frypot whenever needed.

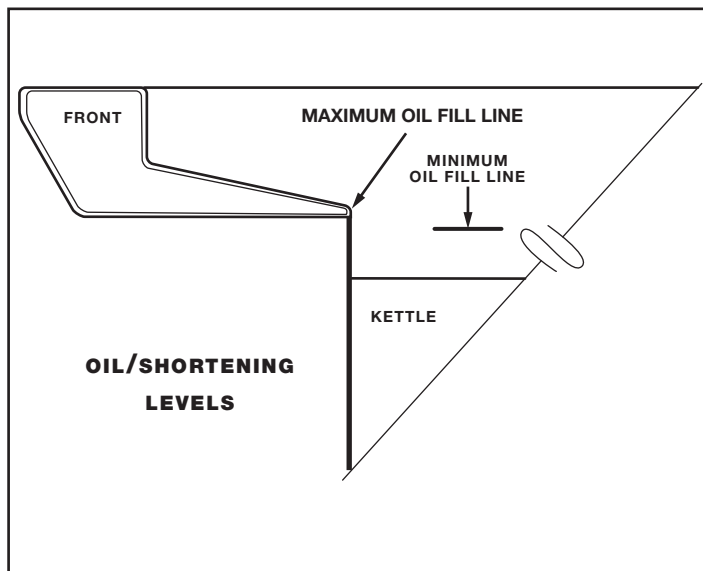

WARNING

FAILURE TO PLACE SOLID SHORTENING DIRECTLY ON THE BOTTOM OF THE FRYPOT CAN CAUSE SERIOUS EQUIPMENT DAMAGE.

CAUTION

ENSURE THERE IS NO WATER IN THE FRYPOT BEFORE FILLING WITH OIL/SHORTENING. WHEN COOKING COMPOUNDS ARE HEATED TO COOKING TEMPERATURE, WATER IN THE FRYPOT WILL CAUSE OIL TO SPLATTER AND MAY BE A BURN HAZARD.

Check the quality of the oil/shortening in the frypot on a daily basis for signs of deterioration. Use an approved test kit. Signs of shortening deterioration include excessive boiling, smoking, foaming, bad taste, and rancid odor. Discard any shortening before it degrades to the point of affecting product quality. Always filter the oil on a regular basis and keep the frypot clean.

FLASH POINT

DANGER

THE FLASH POINT OF SHORTENING OCCURS AT A LOWER TEMPERATURE THE LONGER THE SHORTENING IS USED. DISCARD ANY SHORTENING SHOWING SIGNS OF DETERIORATION TO AVOID SERIOUS BURNS, FIRE AND PROPERTY DAMAGE.

BASIC CONTROL

Maximum shortening life is achieved by turning the fryer stations off when not in use. In multiple-station units, heat only the component fryers necessary to meet cooking needs.

DELUXE CONTROL

Maximum shortening life is achieved by lowering the temperature of the fryer to 250°F (121°C) whenever the fryer is not being used. This is an automatic program function through the control program designation of "IdleMode." The factory default is set at a period of 30 minutes of non use before triggering a temperature decrease, however; this time period can be adjusted between "0" and "60" minutes. (SEE PROGRAMMING THE CONTROL)

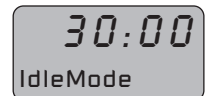

CAUTION

FIRE OR EQUIPMENT DAMAGE CAN RESULT FROM IMPROPER SHORTENING LEVELS. THE LEVEL OF SHORTENING MUST ALWAYS BE ABOVE THE HEATING ELEMENTS WHEN THE FRYER IS OPERATING. THE REQUIRED SHORTENING LEVEL MUST ALWAYS BE ABOVE THE MINIMUM HOT OIL FILL LINE.

CAUTION

HOT SHORTENING AND SURROUNDING METAL SURFACES BECOME EXTREMELY HOT. TO AVOID BURNS, ALWAYS USE HAND PROTECTION WHEN POURING OIL OR ADDING SHORTENING INTO THE FRYPOT. CONTINUALLY GUARD AGAINST HOT SPLASHING OIL.

OPERATING INSTRUCTIONS

BASIC CONTROL

PANEL IDENTIFICATION

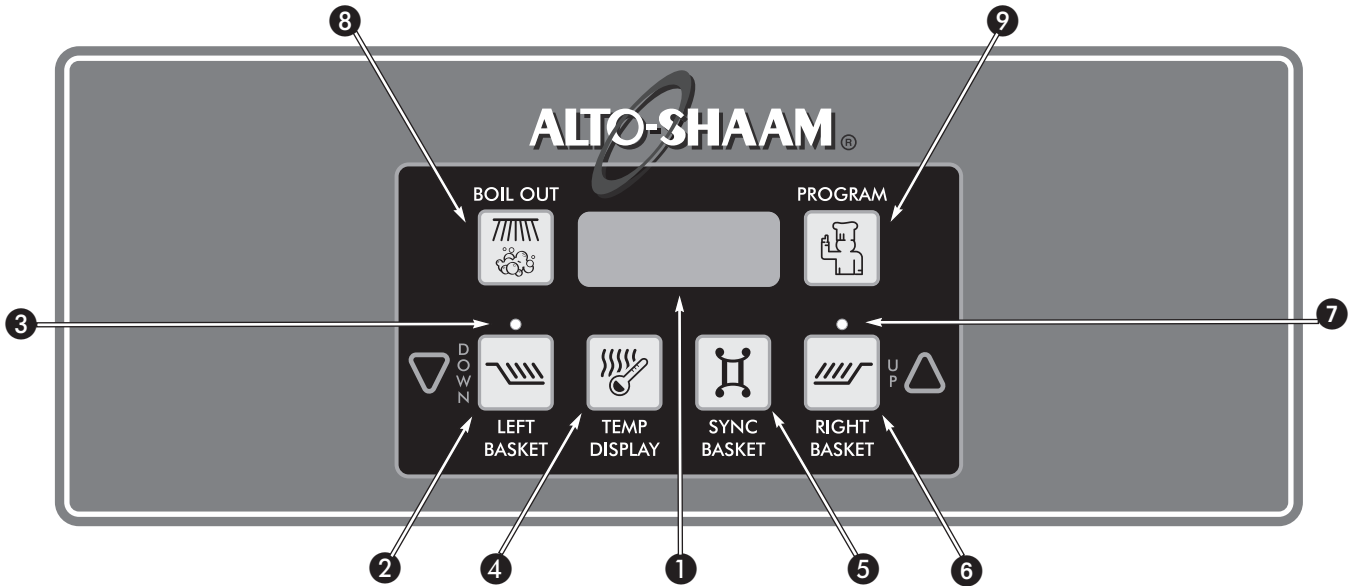

CONTROL PANEL IDENTIFICATION

1. L.E.D. 4-DIGIT DISPLAY	6. RIGHT BASKET BUTTON
2. LEFT BASKET BUTTON	7. RIGHT BASKET INDICATOR LIGHT
3. LEFT BASKET INDICATOR LIGHT	8. BOIL OUT BUTTON
4. TEMP DISPLAY BUTTON	9. PROGRAM BUTTON
5. SYNC BASKET BUTTON (Optional)	

	CAUTION
	<p>HOT SHORTENING AND SURROUNDING METAL SURFACES BECOME EXTREMELY HOT. TO AVOID BURNS, ALWAYS USE HAND PROTECTION WHEN POURING OIL OR ADDING SHORTENING INTO THE FRYPOT. CONTINUALLY GUARD AGAINST HOT SPLASHING OIL.</p>

OPERATING INSTRUCTIONS

BASIC CONTROL

START UP & GENERAL OPERATION

NOTE: Perform an initial Boil-Out to clean and sanitize the fryer station before operating.

1. Service is to be performed by an authorized Alto-Shaam service agent.
2. Assure all local electrical codes, fire codes, and all other requirements such as hood installation have been met in the process of installation.

NOTE: Because each fryer station is controlled separately, the following procedures must be followed for every component fryer in multiple-station units.

3. Open front access door and ensure drain valve is closed. **The handle should be rotated clockwise until it stops.**
4. Fill frypot with frying compound as indicated.
(SEE ILLUSTRATION ON THE OIL/SHORTENING REQUIREMENTS PAGE)
5. The Master Power Switch is located behind the front access door. Turn Master Power Switch **“ON.”**
6. The **LED** display on the control panel will indicate **“-AS-”**, the software version, and then **“CY”**.
7. When the fryer has reached 135°F, the melt cycle is complete and the **LED** display on the control panel will indicate **“HEAT”**.

8. When the fryer displays the set-point temperature, product can be fried.
9. More detailed operating guidelines along with information on programming are located within this manual.
10. To shut the fryer station down, turn the Master Power Switch located behind the front access door to the **“OFF”** position.

NOTE: FOR YOUR PROTECTION The fryer station is furnished with a hi-limit safety shutoff that will disengage the control if the frying compound temperature in the frypot would ever exceed 415°F (213°C). The **LED** will display **“Hi”**, the heat will shut off, the timer will be cancelled, and a constant alarm will sound. In this event, allow the frying compound temperature to drop below 415°F (213°C). Open the front access door and press the **OIL HI-LIMIT RESET** button for a period of 3-seconds to restart the control.

OPERATING INSTRUCTIONS

BASIC CONTROL

BOIL-OUT

NOTE: Perform an initial Boil-Out to clean and sanitize the fryer station before operating.

Carbonized deposits along with an accumulation of oil will eventually build-up on the interior of the frypot as well as fryer accessories. It is important to periodically remove these deposits, not only to maintain fryer efficiency, but also to provide the highest product quality.

NOTE: Because each fryer station is controlled separately, the following procedure must be followed for every component fryer in multiple-station units.

CAUTION

Before entering this program, make certain the frypot is empty of all oil or shortening. Close the frypot drain. Carefully follow the manufacturer's mixing directions and fill the frypot with a mixture of cold water and fryer boil-out solution.

NOTE: Manual Boil-Out can only be performed when the actual temperature of the frypot is less than 230°F (110°C).

1. Close the **DRAIN**. The handle should be rotated clockwise until it stops.
2. Fill the fryer to the maximum oil fill line with a mixture of cold water and fryer boil-out solution. Carefully follow the manufacturer's directions for mixing the boil-out solution.



CAUTION

TO PROTECT THE PUMP FROM POSSIBLE WATER DAMAGE AFTER THE BOILOUT PROCEDURE, FILL THE KETTLE WITH OIL AND CYCLE THROUGH TO REMOVE ANY EXCESS WATER.

3. Turn the Master Power Switch (located within the front access door) to the **"ON"** position.
4. Wait until the **LED** reads **"HEAT"**, then press the **BOIL OUT** button on the control panel.
5. When 192°F (89°C) is reached, the **LED** will display **"BOIL"** and that temperature will be maintained. Using a separate timer, allow the frypot to boil-out for 10 minutes.



CAUTION

DO NOT leave the fryer unattended during the boil-out process. The fryer must be continuously monitored for boil-over conditions, particularly in high-altitude locations. If boil-over occurs, immediately turn the Master Power Switch located behind the front access door to the **"OFF"** position and allow the solution to cool. When the solution has cooled, re-enter the boil-out mode.

6. Turn the Master Power Switch located behind the front access door to the **"OFF"** position.
7. Attach the drain pipe and direct into a heat-resistant container.
8. Open the **DRAIN**. The handle should be rotated counterclockwise until it stops.
9. Allow the boil-out solution to completely drain. Discard boil-out solution.



CAUTION

ENSURE THERE IS NO WATER IN THE FRYPOT BEFORE FILLING WITH OIL/SHORTENING. WHEN COOKING COMPOUNDS ARE HEATED TO COOKING TEMPERATURE, WATER IN THE FRYPOT WILL CAUSE OIL TO SPLATTER AND MAY BE A BURN HAZARD.

OPERATING INSTRUCTIONS

BASIC CONTROL

LEFT AND RIGHT BASKET OPERATION

NOTE: Because each fryer station is controlled separately, the following procedures must be followed for every component fryer in multiple-station units.

1. Ensure that the fryer has reached the set-point temperature and it is displayed on the control panel.

(FOLLOW INSTRUCTIONS ON THE START UP AND GENERAL OPERATION PAGE)



2. **LOAD PRODUCT** Load product in basket(s) and set basket(s) in the fryer lift brackets.

3.  To operate the left basket, press the **LEFT BASKET** button on the control panel.

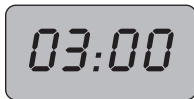

The left basket will lower.

The display will show the programmed time and count down the remaining time for the left basket IF IT HAS LESS TIME LEFT THAN THE RIGHT BASKET.

During cooking, the Left Basket Indicator Light will blink fast if its time is displayed and at a slower rate if its time is not displayed.

4.  To operate the right basket, press the **RIGHT BASKET** button on the control panel.

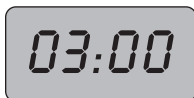

The right basket will lower.

The display will show the programmed time and count down the remaining time for the right basket IF IT HAS LESS TIME LEFT THAN THE LEFT BASKET.

During cooking, the Right Basket Indicator Light will blink fast if its time is displayed and at a slower rate if its time is not displayed.

5. When the programmed time for either basket has expired:

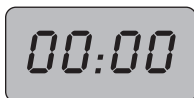

The basket will automatically rise.

The display will show "00:00", then flash "L" or "R", and the alarm will sound on and off.

CONTINUED

OPERATING INSTRUCTIONS

BASIC CONTROL

LEFT AND RIGHT BASKET OPERATION

6. Press the **LEFT BASKET** or **RIGHT BASKET** button to stop alarm.

7. REMOVE PRODUCT

NOTE: To stop the cooking function of either basket before the programmed time, press the **LEFT BASKET** or **RIGHT BASKET** button.

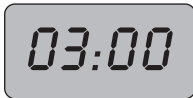

The Indicator Light for that basket will go out.

The display will revert to the other basket's remaining time or the frypot temperature.

The basket will automatically rise.

SHUTDOWN

To shut the fryer station down, turn the Master Power Switch located behind the front access door to the **"OFF"** position.



The basket will automatically rise.

The display will become blank.

OPERATING INSTRUCTIONS

BASIC CONTROL

SYNCHRONIZED BASKETS OPTION

NOTE: Because each fryer station is controlled separately, the following procedures must be followed for every component fryer in multiple-station units.

1. Ensure that the fryer has reached the set-point temperature and it is displayed on the control panel.

(FOLLOW INSTRUCTIONS ON THE START UP AND GENERAL OPERATION PAGE)

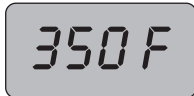

2. **LOAD PRODUCT** Load product in baskets and set baskets in the fryer lift brackets.

3.  To operate the both baskets simultaneously, press the **SYNC BASKET** button on the control panel along with either the **LEFT BASKET** or **RIGHT BASKET** button.

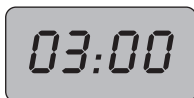

Both baskets will lower.

The display will show the programmed time and count down the remaining time.

During cooking, the Indicator Light of the pushed button will blink fast.

4. When the programmed time has expired:

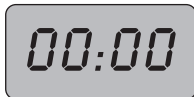

The baskets will automatically rise.

The display will show “00:00”, then flash “L” or “r”, depending on the pushed button, and the alarm will sound on and off.

5. Press the **LEFT BASKET** or **RIGHT BASKET** button to stop alarm.

6. **REMOVE PRODUCT**

NOTE: Another cooking function can not be started during a synchronized cooking function.

OPERATING INSTRUCTIONS

BASIC CONTROL

CONTROL PROGRAMMING OVERVIEW

CAUTION

This section is provided for the assistance of qualified personnel only and is not intended for use by untrained or unauthorized personnel.

NOTE: Because each fryer station is controlled separately, the following procedures must be followed for every component fryer in multiple-station units.

Control Programming allows you to:

- Set the left and right timers
- Choose the set-point temperature
- Choose the correct melt cycle for our frying compound
- Lock the Control Programming
- Select °F or °C for the temperature display

Press the **“PROGRAM”** button  to enter Control Programming.



OR



Press the **LEFT BASKET** or **RIGHT BASKET** button to scroll through the choices for each function.



Pressing the **PROGRAM** button confirms the change and moves on to the next function.



+ **HOLD**

Pressing and holding the **PROGRAM** button for one second exits Control Programming.

OPERATING INSTRUCTIONS

BASIC CONTROL

PROGRAMMING THE CONTROL

CAUTION



This section is provided for the assistance of qualified personnel only and is not intended for use by untrained or unauthorized personnel.

NOTE: Because each fryer station is controlled separately, the following procedures must be followed for every component fryer in multiple-station units.



1. Enter Control Programming. Press the **PROGRAM** button.

- If unlocked, the display will go right into the Control Programming sequence.
- If locked, **“LoC”** will display, and the password routine must be pressed. (The password routine = **LEFT BASKET - LEFT BASKET - RIGHT BASKET - RIGHT BASKET**.)



2. Set the left and right timer. First, the Left Basket Indicator Light will come on and the currently set time for the left basket will appear in the **LED** with its colon flashing.

- Scroll up or down in one second increments by pressing  or .
- Press  to accept the new setting and proceed to the right basket timer.



Then, the Right Basket Indicator Light will come on and the currently set time for the right basket will appear in the **LED** with its colon flashing.

- Scroll up or down in one second increments by pressing  or .
- Press  to accept the new setting and go on to the set-point temperature.

3. Choose the set-point temperature. The current set-point temperature will appear in the **LED** with a flashing **“F”** or **“C”**.

- Scroll up or down in one degree increments by pressing  or .
- Press  to accept the new setting and proceed to offset the temperature.

4. Calibrate (offset) the temperature. The current offset temperature will appear in the **LED**, always in °F. The offsets available range from -20°F to 20°F.

- Scroll up or down in one degree increments by pressing  or .
- Press  to accept the new setting and proceed to the melt cycle.

OPERATING INSTRUCTIONS



BASIC CONTROL

PROGRAMMING THE CONTROL

CAUTION



This section is provided for the assistance of qualified personnel only and is not intended for use by untrained or unauthorized personnel.

5. Choose the correct melt cycle for your frying compound. The melt cycle will appear in the **LED** as “**CY L**” or “**CY S**”. “**CY L**” is for liquid frying compounds such as oil and “**CY S**” is for solid frying compounds such as shortening. Do not choose “**CY 0**”.





- Scroll to change melt cycles by pressing  or .
- Press  TWICE to accept the new setting and proceed to the lock.

NOTE: Do not press just once and change the “**gAS**” or “**ELEC**” setting.

6. Lock or unlock the Control Programming. “**LoC**” or “**ULoC**” will appear in the **LED** display. “**LoC**” will prohibit unqualified personnel (without the password) from entering Control Programming. “**ULoC**” will leave Control Programming unlocked.

- Scroll to change lock condition by pressing  or .
- Press  to accept the new setting and proceed to select °F or °C.

7. Select °F or °C for the temperature display. “**F**” or “**C**” will appear in the **LED** display. “**F**” will cause the **LED** to display Fahrenheit. “**C**” will cause the **LED** to display Celsius.

- Scroll to change from °F to °C by pressing  or .
- Press  to accept the new setting and proceed to restart Control Programming sequence or press and hold  for one second to exit Control Programming.

NOTE: At any point in the sequence, pressing and holding  for one second will exit Control Programming.

OPERATING INSTRUCTIONS

BASIC CONTROL

TEMPERATURE VERIFICATION

NOTE: Because each fryer station is controlled separately, the following procedures must be followed for every component fryer in multiple-station units.



The temperature of the cooking oil/shortening and the temperature set-point can be verified at any time.

Press **TEMP DISPLAY** button once to verify the actual temperature of the cooking oil/shortening.

Press **TEMP DISPLAY** button twice to verify the set-point temperature.

Press **TEMP DISPLAY** button three times to return the **LED** to its previous reading. The **LED** will also automatically return to its previous reading after three (3) seconds.

If a defective probe is suspected, measure the temperature of the oil/shortening with a thermometer. Compare the thermometer reading with the temperature shown in the control to make certain the readings are reasonably

ALARM MESSAGES

	PROBABLE CAUSE	SOLUTION
	Probe open. Probe wired wrong.	Refer to wiring diagram for correct wiring. Measure probe in ice water bath for 100 ohms resistance.
	Probe shorted. Hi-limit tripped.	Contact Alto-Shaam service. Allow frypot to cool and press the OIL HI-LIMIT RESET button for three (3) seconds.
 	Drain valve interlock.	Turn Master Power Switch off, ensure the drain is closed, and turn Master Power Switch back on.

close. If there is a wide discrepancy, perform a complete fryer station shutdown and contact Alto-Shaam service.

CARE AND CLEANING

CLEANING & MAINTENANCE



THOROUGHLY CLEAN DAILY

The cleanliness and appearance of this unit will contribute considerably to operating efficiency and savory, appetizing food. Good equipment kept clean works better and lasts longer.

1. Disconnect unit from power source, and let cool.
2. Remove all detachable items. Clean these items separately with a good grease solvent or commercial detergent. Rinse well and dry.
3. Clean control panel, door vents, door handles, and door gaskets thoroughly since these areas harbor food debris. Rinse by wiping with sponge and clean warm water. Wipe dry with a clean cloth.

4. To help maintain the protective film coating on polished stainless steel, clean the exterior of the unit with a cleaner recommended for stainless steel surfaces. Spray the cleaning agent on a clean cloth and wipe with the grain of the stainless steel.

NOTE: Avoid the use of abrasive cleaning compounds, chloride based cleaners, or cleaners containing quaternary salts. Never use hydrochloric acid (muriatic acid) on stainless steel.

Always follow appropriate state or local health (hygiene) regulations regarding all applicable cleaning and sanitation requirements for foodservice equipment.



OPERATING INSTRUCTIONS

ALL SUGGESTED FRYING TIMES ARE BASED ON A FULL LOAD OF PRODUCT

SUGGESTED FRYING TIMES

ITEM		MINUTES	TEMPERATURE	DISPLAY
PROGRAM KEYS	1. Fries (FROZEN)	3:30	350°F (177°C)	Fries
	2. Chicken Nuggets (FROZEN)	3:30	350°F (177°C)	Nuggets
	3. Fish, Breaded (FROZEN)	4:30	350°F (177°C)	Fish
	4. Chicken Pieces, Breaded (FRESH)	17:00	340°F (171°C)	Chicken
	5. PRODUCT A			ProductC
	6. PRODUCT B			ProductD

ITEM	MINUTES	TEMPERATURE
Appetizer	3:30	350°F (177°C)
Breaded Cauliflower	3:30	340°F (171°C)
Breaded Fish	Per pkg. instructions	340°F (171°C)
Breaded Mac & Cheese	3:30	340°F (171°C)
Breaded Mushrooms	3:30	340°F (171°C)
Broccoli Cheese Nuggets	2:30	350°F (177°C)
Cheese Cake, Fried	8:30	350°F (177°C)
Cheese Nuggets	1:30	350°F (177°C)
Chicken Breasts (FRESH)	12:00-17:00	315°F (171°C)
Chicken Breasts (FROZEN)	20:00	330°F (166°C)
Chicken Fried Steak	4:00	350°F (177°C)
Chicken Gizzards (FRESH)	3:30	350°F (177°C)
Chicken, Legs & Wings (FRESH)	12:00-17:00	315°F (171°C)
Chicken Legs (FROZEN)	18:00	330°F (166°C)
Chicken, Patty	6:00	350°F (177°C)
Chicken Pieces - MRB (FROZEN)	17:00	340°F (171°C)
Chicken Strips	6:00	340°F (171°C)
Chicken Tenderloins (FRESH)	3:00	350°F (177°C)
Chicken Tenders, Breaded (FROZEN)	3:30	350°F (177°C)
Chicken Wings (FRESH)	3:30	350°F (177°C)
Chicken Wings (FROZEN)	15:00	330°F (177°C)
Clam Strips	2:00	340°F (171°C)
Corn Dogs	10:00	350°F (177°C)
Cream Cheese Jalapeño Poppers	3:30	340°F (171°C)
Eggplant	4:00	340°F (171°C)

THE TIMES AND TEMPERATURES ARE SUGGESTED GUIDELINES ONLY. ALL COOKING SHOULD BE BASED ON INTERNAL PRODUCT TEMPERATURES. DUE TO VARIATIONS IN PRODUCT QUALITY, WEIGHT, AND DESIRED DEGREE OF DONENESS, THE COOKING TIMES AND TEMPERATURES MAY NEED TO BE ADJUSTED ACCORDINGLY. ALWAYS FOLLOW LOCAL HEALTH (HYGIENE) REGULATIONS FOR ALL INTERNAL TEMPERATURE REQUIREMENTS.

OPERATING INSTRUCTIONS

ALL SUGGESTED FRYING TIMES ARE BASED ON A FULL LOAD OF PRODUCT

SUGGESTED FRYING TIMES		
ITEM	MINUTES	TEMPERATURE
Egg Rolls (FROZEN)	5:00	340°F (171°C)
Fries, Crinkle-Cut	5:00	340°F (171°C)
Fries, Seasoned	4:00	340°F (171°C)
Fries, Sour Cream & Chive	4:00	340°F (171°C)
Fries (FRESH)	5:00	340°F (171°C)
Fries, Thin Cut	3:30	340°F (171°C)
Hash Brown Circles	4:00	340°F (171°C)
Jalapeno Peppers, Stuffed	4:00	350°F (177°C)
Mozzarella Sticks, Battered or Breaded	Per pkg. instructions	340°F (171°C)
Mushrooms, Breaded	3:30	350°F (177°C)
Onion Rings	3:00	340°F (171°C)
Pork Chops (FRESH)	10:00	340°F (171°C)
Pork (FRESH)	12:00	340°F (171°C)
Potato Chips (fresh)	2:45	325°F (163°C)
Potato Wedges	3:00	350°F (177°C)
Quesadilla Rolls	3:30	350°F (177°C)
Shrimp	3:30	340°F (171°C)
Vegetables	3:00	350°F (177°C)
Zucchini, Breaded (FRESH)	3:30	350°F (177°C)

THE TIMES AND TEMPERATURES ARE SUGGESTED GUIDELINES ONLY. ALL COOKING SHOULD BE BASED ON INTERNAL PRODUCT TEMPERATURES. DUE TO VARIATIONS IN PRODUCT QUALITY, WEIGHT, AND DESIRED DEGREE OF DONENESS, THE COOKING TIMES AND TEMPERATURES MAY NEED TO BE ADJUSTED ACCORDINGLY. ALWAYS FOLLOW LOCAL HEALTH (HYGIENE) REGULATIONS FOR ALL INTERNAL TEMPERATURE REQUIREMENTS.

OPERATING INSTRUCTIONS

DELUXE CONTROL

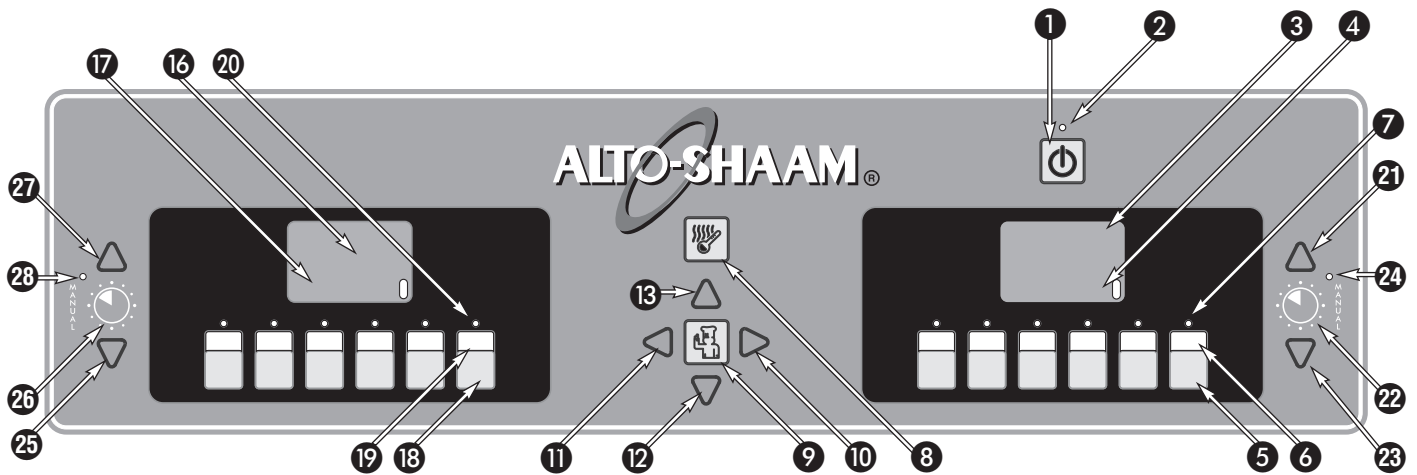

DUAL CONTROL PANEL IDENTIFICATION

1. POWER ON KEY	15. —
2. POWER ON INDICATOR LIGHT	16. L.E.D. 4-DIGIT DISPLAY
3. L.E.D. 4-DIGIT DISPLAY	17. ALPHA/NUMERIC DISPLAY
4. ALPHA/NUMERIC DISPLAY	18. PROGRAMMED PRODUCT KEYS (6)
5. PROGRAMMED PRODUCT KEYS (6)	19. PROGRAMMED PRODUCT WINDOWS (6)
6. PROGRAMMED PRODUCT WINDOWS (6)	20. PROGRAMMED PRODUCT INDICATOR LIGHTS
7. PROGRAMMED PRODUCT INDICATOR LIGHTS	21. MANUAL OPERATION UP ARROW KEY
8. TEMPERATURE KEY	22. MANUAL OPERATION TIME KEY
9. PROGRAMMING KEY	23. MANUAL OPERATION DOWN KEY
10. RIGHT ARROW KEY	24. INDICATOR LIGHT
11. LEFT ARROW KEY	25. MANUAL OPERATION DOWN KEY
12. DOWN ARROW KEY	26. MANUAL OPERATION TIME KEY
13. UP ARROW KEY	27. MANUAL OPERATION UP ARROW KEY
14. —	28. INDICATOR LIGHT

CAUTION

HOT SHORTENING AND SURROUNDING METAL SURFACES BECOME EXTREMELY HOT. TO AVOID BURNS, ALWAYS USE HAND PROTECTION WHEN POURING OIL OR ADDING SHORTENING INTO THE FRYPOT. CONTINUALLY GUARD AGAINST HOT SPLASHING OIL.

OPERATING INSTRUCTIONS

DELUXE CONTROL

START UP & GENERAL OPERATION

NOTE: Perform an initial Boil-Out to clean and sanitize the fryer before operating.

1. Service is to be performed by an authorized Alto-Shaam service agent.
2. Assure all local electrical codes, fire codes, and all other requirements such as hood installation have been met in the process of installation.
3. Open front access door and ensure drain valve is in the **"CLOSED"** position. **The handle should be rotated clockwise until it stops.**
4. Fill frypot with frying compound as indicated.
(SEE ILLUSTRATION ON THE OIL/SHORTENING REQUIREMENTS PAGE)
5. The Master Power Switch is located behind the front access door. Turn Master Power Switch **"ON."**
6. Both **LED** displays on the control panel will indicate **"OFF"** when the Master Power Switch is initially turned to the **"ON"** position.
7. Press and hold the Power **"ON"** Key on the main control panel for 3 seconds. Both **LED** displays on the control panel will indicate actual oil temperature or ambient room temperature. The bottom of alpha/numeric display will indicate **"MELT-CYCLE."** It is recommended to allow the fryer to complete the "Melt Cycle" when using solid shortening; however, if liquid shortening is used the "Melt Cycle" may be bypassed by pressing Temperature Key  for 3 seconds.

8. After fryer has reached the factory-set oil temperature of 350°F (177°C) or the temperature set by the operator, product can be fried.
9. More detailed operating guidelines along with information on presets and other options are located within this manual.
10. For fryer Shutdown press the Power Key on the main control panel to the **"OFF"** position.



- ▶ Turn the Master Power Switch located behind the front access door to the **"OFF"** position.

NOTE: FOR YOUR PROTECTION The fryer is furnished with a hi-limit safety shutoff that will disengage the control if the oil temperature in the frypot would ever exceed 432°F (222°C). In this event, the oil temperature must be allowed to decrease to 375°F (191°C) before restarting the appliance. After allowing the oil temperature to decrease, open the front access door and press the **RESET BUTTON** for a period of 3-seconds to restart the control.



OPERATING INSTRUCTIONS

DELUXE CONTROL

START UP & GENERAL OPERATION

BOIL-OUT

NOTE: Perform an initial Boil-Out to clean and sanitize the fryer before operating.

Carbonized deposits along with an accumulation of oil will eventually build-up on the interior of the frypot as well as fryer accessories. It is important to periodically remove these deposits, not only to maintain fryer efficiency but also to provide the highest product quality.

1. Open the front access door. With the Kettle/Nozzle selector in the “**KETTLE**” position, rotate the drain valve clockwise until rotation stops and the drain valve is “**CLOSED.**”
2. Fill the fryer **ONLY** to the maximum hot oil fill line with a mixture of cold water—then add fryer boil-out solution. Carefully follow the manufacturer's directions for mixing the boil-out solution. **DO NOT LEAVE UNATTENDED.**

CAUTION

Before entering this program, make certain the frypot is empty of all oil or shortening. Close the frypot drain. Carefully follow the manufacturer's mixing directions and fill the frypot with a mixture of cold water and fryer boil-out solution.

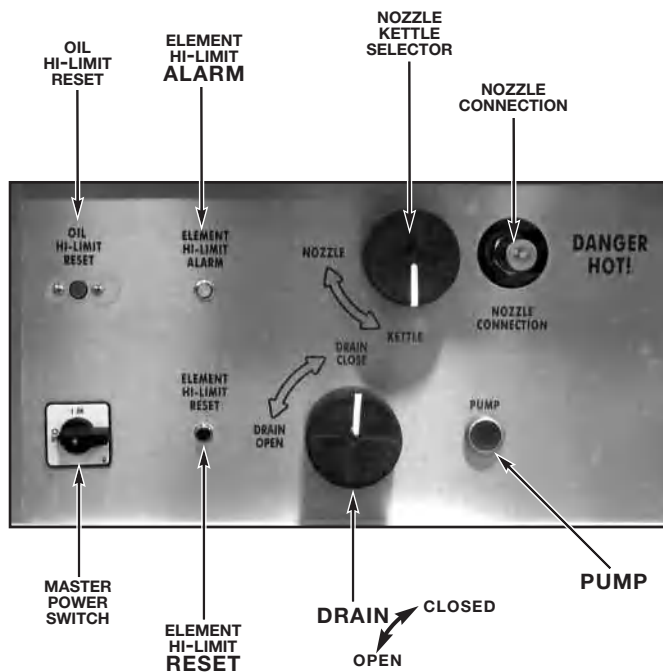
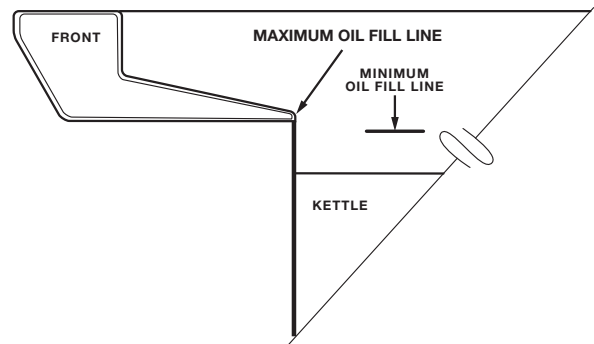

3. Turn the Master Power Switch (located within the front access door) to the “**ON**” position.

Within a few seconds, both LED's on the operational control panel will display “**OFF**” when the Master Power Switch is initially engaged.

CAUTION

DO NOT leave the fryer unattended during the boil-out process. The fryer must be continuously monitored for boil-over conditions, particularly in high-altitude locations. If boil-over occurs, immediately press the power key to the “**OFF**” position and allow the solution to cool. When the solution has cooled, re-enter the boil-out mode.

NOTE: Initial access to the programming mode must start with the control in the “**OFF**” position.

Off

To protect the pump from possible water damage after the boilout procedure, fill the kettle with oil and cycle through to remove any excess water.

OPERATING INSTRUCTIONS

DELUXE CONTROL

START UP & GENERAL OPERATION

BOIL-OUT

4. Press and hold the Program Key for 10 seconds.



“**Boil**” will always appear as the first item in the display whenever the “**PROGRAM**” key is initially pressed.

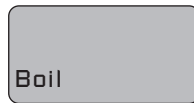

Press the Right ▶ arrow key to enter the “**Boil**” program.

The display will indicate “**READY?**”. Press the Right ▶ arrow key to start the boil-out function. The boil-out solution will begin to heat to a temperature of 195°F (91°C). When the temperature has been reached, the appliance will begin a 10 minute countdown.

NOTE: THE COUNTDOWN PERIOD WILL NOT SHOW IN THE DISPLAY.

At the end of the boil-out period, an alarm will sound and the control will revert to the “**OFF**” state.

5. Rotate the **DRAIN** to the “**OPEN**” position. Allow the boil-out solution to completely drain. Discard boil-out solution per manufacturer’s recommendation, and return the trolley to the fully inserted position beneath the fryer.
6. Rotate the drain valve clockwise to the “**CLOSED**” position and follow the manufacturer’s additional boil-out instructions to rinse the frypot in order to neutralize boil-out cleaner residue. Drain and discard the rinsing solution.

7. Following the boil-out procedure and rinse, wipe all accessible metal surfaces in the interior and wipe all interior accessories with a clean, dry cloth to remove remaining rinsing solution. Clean and dry the fry baskets separately.

8. Wipe the exterior of the fryer cabinet with a degreaser/sanitizer suitable for use on food contact surfaces. Always follow the manufacturer’s instructions and/or mixing directions for proper solution strengths.

Wipe exterior stainless steel surfaces with the grain of the metal and avoid the use of abrasive pads, steel wool, or metal implements.

9. Replace the oil filter.

 **CAUTION**

ENSURE THERE IS NO WATER IN THE FRYPOT BEFORE FILLING WITH OIL/SHORTENING. WHEN COOKING COMPOUNDS ARE HEATED TO COOKING TEMPERATURE, WATER IN THE FRYPOT WILL CAUSE OIL TO SPLATTER AND MAY BE A BURN HAZARD.

 **CAUTION**

BOIL-OUT SOLUTION AND SURROUNDING METAL SURFACES BECOME EXTREMELY HOT. TO AVOID BURNS, ALWAYS USE HAND PROTECTION WHEN PERFORMING THE BOIL-OUT FUNCTION AND FOLLOW THE MANUFACTURER’S SAFETY INSTRUCTIONS FOR THE BOIL-OUT PRODUCT BEING USED.



OPERATING INSTRUCTIONS

DELUXE CONTROL

PROGRAMMED PRODUCT KEY OPERATION

1. TURN THE POWER SWITCH LOCATED BEHIND THE LOWER FRONT ACCESS DOOR TO THE "ON" POSITION.

Press the "**HI-LIMIT RESET**" button.

- ▶ The **HI-LIMIT ALARM** light will go out.
- ▶ Both **LED** displays on the control panel will indicate "**OFF.**"

2. Press and hold the "**ON/OFF**" key for 1-1/2 to 2 seconds to energize the fryer. The indicator light within the display will illuminate to signify that the control is cycling the heaters to reach the set-point.

⇨ The following will appear in the alpha/numeric display:

"MeltCyl"



The fryer will start the melt-cycle mode. This is the required mode necessary for melting solid shortening within the frypot. The fryer will generate **ON/OFF** heating cycles and will remain in this mode until 180°F (82°C) is reached or the mode is manually bypassed.



FOR USE WITH LIQUID SHORTENING, PRESS THE TEMPERATURE KEY FOR 4 SECONDS TO BYPASS THE MELT CYCLE.

"PREHEAT"



Preheat will appear in the display and the fryer will generate a continuous heating cycle until it reaches the operator pre-programmed set-point or a default temperature of 350°F (177°C).

"READY"

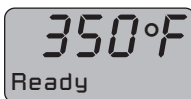

When the frypot temperature is reached, "**READY,**" will appear in the Alpha/Numeric Display.

3. LOAD PRODUCT

Load product in basket(s) and set basket(s) in the fryer lift brackets. The basket(s) will automatically lower into the oil after the product key is pressed.



Press and hold the desired "**PROGRAMMED PRODUCT KEY**" for 1 second.

⇨ The indicator light for the selected product key will illuminate.

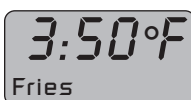

The basket lift (ON LIFT EQUIPPED FRYERS ONLY) will lower the product into the cooking oil/shortening.

The display will indicate the product name and the programmed cook time. The control will begin a countdown of the time.

CONTINUED

OPERATING INSTRUCTIONS

DELUXE CONTROL

PROGRAMMED PRODUCT KEY OPERATION

5. If shake-time has been programmed into the selected product:



An alarm will sound during the cooking cycle at the specified shake-time programmed. **“SHAKE”** will appear in the display. The basket will automatically lift 50-percent and the display will count down from the shake time programmed.



After shaking the product, both the alarm and display can be cleared by pressing the selected product key. The basket will automatically lower into the cooking position and the cooking time will resume.

NOTE: This function will not occur if shake time has not been programmed into the selected product.

6. At the end of the cooking cycle...

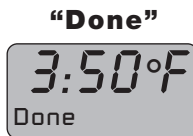

The basket(s) will lift (ON LIFT EQUIPPED FRYERS ONLY).

An alarm will sound.

The indicator light within the display will begin to flash.



To cancel the **“DONE”** alarm, press the illuminated product key. The alarm will stop in 10 seconds. In 5-seconds, the display will revert to the 350°F (177°C) **“READY”** state if a hold value has not been programmed.

7. **“Hold Done”**

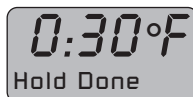

If a hold value has been entered into the cooking program, the control alarm will sound and the basket will automatically lift. The hold time will be displayed and countdown will begin. When the hold timer reaches 0, an alarm will sound and the product indicator light within the display will flash.

⇨ Cancel the alarm by pressing the product key.

NOTE: If no hold value has been programmed, the control will skip to item 8.

8. **“READY”**

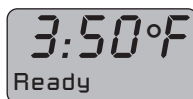

The control will revert to the ready state.

“READY,” will appear in the Alpha/Numeric Display.

The 4-digit display will indicate the operator set temperature or the default set-point of 350°F (177°C).

OPERATING INSTRUCTIONS

DELUXE CONTROL

MANUAL OPERATION

-  Press and hold the **“ON/OFF”** key for 1 second to energize the fryer.
⇨ The following will appear in the Alpha/Numeric Display:

“MELTCYL”

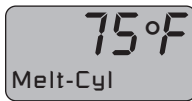

The fryer will start the melt-cycle mode. This is the required mode necessary for the melting solid shortening within the frypot. The fryer will generate **ON/OFF** heating cycles and will remain in this mode until 180°F (82°C) is reached or the mode is manually bypassed.



FOR USE WITH LIQUID SHORTENING, PRESS THE TEMPERATURE KEY FOR 4 SECONDS TO BYPASS THE MELT CYCLE.

“PREHEAT”



The fryer will generate a continuous heating cycle until reaches the operator pre-programmed set-point or a default temperature of 350°F (177°C).

“READY”

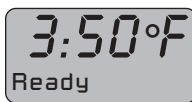

When the frypot temperature is reached, **“READY”**, will appear in the Alpha/Numeric Display.

2. LOAD PRODUCT

Load product in basket(s) and set basket(s) in the fryer lift brackets. The basket(s) will automatically lower into the oil after the correct amount of time has been entered and the manual time key is pressed.

-  Press the **“MANUAL TIME KEY”** when **“READY”** appears in the Alpha/Numeric Display.



The previously set time (IN MINUTES) or **“0:00”** will begin to flash in the display.

4. PRESS THE UP ▲ AND DOWN ▼ ARROW KEYS TO ADJUST THE AMOUNT OF TIME.

CONTINUED

OPERATING INSTRUCTIONS

DELUXE CONTROL

MANUAL OPERATION

5.  Press the **“MANUAL TIME KEY”** after the correct amount of time has been entered.

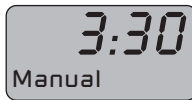

The fryer basket will automatically lower into the cooking shortening/oil.

The displayed time will begin to count down the remaining time.

NOTE: To stop the manual cooking function before time has expired:

Press and hold the **“MANUAL TIME KEY”** for 1-second.

↪ The display will revert to **“0:00.”**

The control will produce an audible signal.

The basket will automatically rise.

Manual has own set point. Use right/left arrow keys to adjust.

May be adjusted during cook cycle.

SHUTDOWN

1.  Press and hold the **“ON/OFF”** key on the main control panel for 2 seconds.



The alpha/numeric will display **“OFF.”**

The baskets will automatically lift.

The display will become blank.

2. Turn the Master Power Switch (located behind the front access door) to the **“OFF”** position.

OPERATING INSTRUCTIONS

DELUXE CONTROL

CONTROL PROGRAMMING OVERVIEW



Initial access to the programming mode must start with the control in the **“OFF”** position.

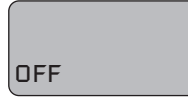

Entering the **PROGRAM** mode provides the operator with the ability to modify all control functions and provides access to the boil-out **“BOIL”** feature.

A programming capability of the fryer offers the following functions and features. Some of these operating parameters have been preset at the factory and are described in the control programming section:

“Boil”	“Basket Lift”	“Language”	“IdleMode”	“Max Time”	“Hi Band”
“Set-Point”	“LiftSync”	“TempDisp”	“Filter”	“Hi Temp”	“Melt Ct”
“Product”	“Temp F-C”	“AlarmSet”	“Filter Cnt”	“Lo Band”	“Preheat Band”

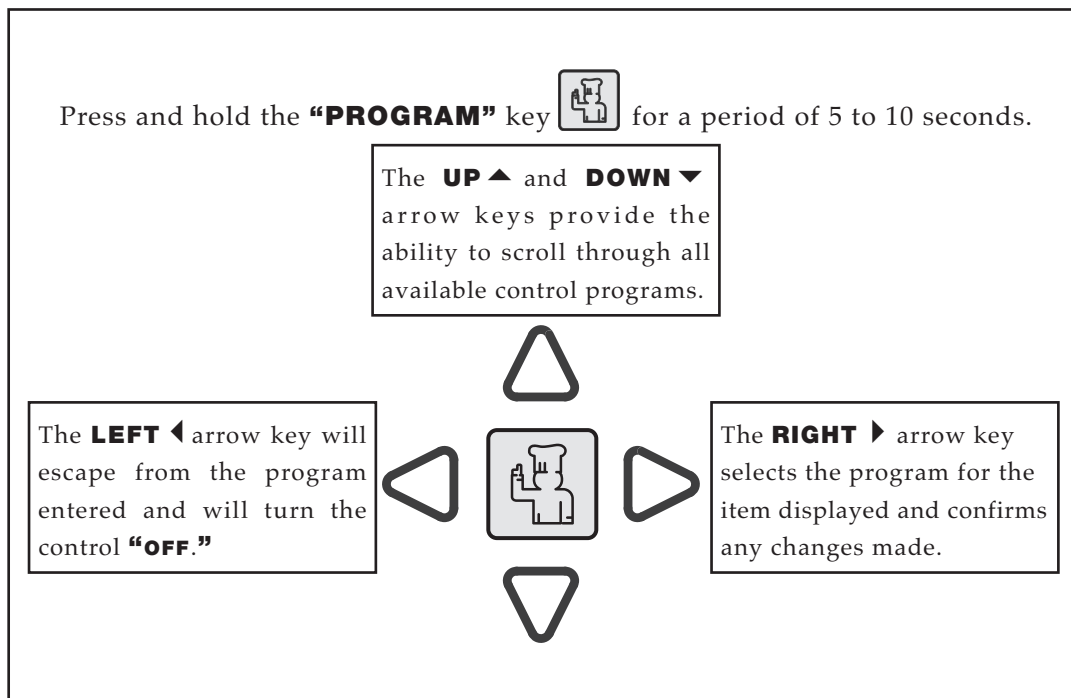

To exit the control programming mode at any time, press and hold the LEFT ◀ arrow key.

OPERATING INSTRUCTIONS

DELUXE CONTROL

PROGRAMMING THE CONTROL

Starting with the control in the **“OFF”** position, press and hold the **“PROGRAM”** key



for a period of 5 to 10 seconds.

“Boil” will always appear as the first item in the display whenever the **“PROGRAM”** key is initially pressed. Detailed boil-out instructions are located on **PAGE 12** of this manual.

Press the DOWN ▼ arrow key to bypass the “Boil” program.

“Boil”

Boil

Press the right ▶ arrow key enter the **“Boil”** program (**SEE PAGE 12**).

NOTE: Before entering this program, make certain the frypot is empty of all oil or shortening. Close the frypot drain. Carefully follow the manufacturer's mixing directions and fill the frypot with a mixture of cold water and fryer boil-out solution.

Ready ?

The display will indicate **“READY ?”**. Press the right ▶ arrow key to start the boil-out function. The boil-out solution will begin to heat to a temperature of 195°F (91°C). When the temperature has been reached, the display will begin a 10 minute countdown.



CAUTION

DO NOT leave the fryer unattended during the boil-out process. The fryer must be continuously monitored for boil-over conditions, particularly in high-altitude locations. If boil-over occurs, immediately press the power key to the **“OFF”** position and allow the solution to cool.

When the solution has cooled, re-enter the boil-out mode.

At the end of the boil-out period, an alarm will sound and the control will revert to the **“OFF”** state.

To exit the control programming mode at any time, press and hold the LEFT ◀ arrow key.

OPERATING INSTRUCTIONS

DELUXE CONTROL

PROGRAMMING THE CONTROL

350°F
SetPoint

This program allows the operator to change the temperature of the frypot oil/shortening. The set-point temperature of the oil/shortening can be adjusted from a range of 250°F to 450°F (121°C to 232°C). The factory default is set at 350°F (177°C).

Press the Up ▲ or Down ▼ arrow keys to scroll until **“SetPoint”** appears in the display. Press the right ► arrow key to enter the program. The display will stop flashing. The previously set temperature will appear in the display. Press the Up ▲ or Down ▼ arrow keys to change the setting. When the correct set-point appears, press the right ► arrow key to confirm the setting. The display will flash. Press the down ▼ arrow key to advance the control to the next program feature.

To exit the control programming mode at any time, press and hold the LEFT ◀ arrow key.

OPERATING INSTRUCTIONS

DELUXE CONTROL

PROGRAMMING THE CONTROL

“Product”

Product

The fryer control has been preset at the factory with four product menu items and two programmable spaces in the dual control.

1. Fries 2. Nuggets 3. Fish 4. Chicken 5. PRODUCT A 6. PRODUCT B

The number of available product keys is directly linked to the “LiftSync” program that provides the ability to raise both baskets simultaneously or independently. If “LiftSync” is set in the “ON” position to raise both baskets at the same time, the “Product” function provides six (per side) available product keys for programming. If “LiftSync” is set to the “OFF” position to raise each basket independently, the “Product” control feature provides twelve available product keys for programming, six on each side of the control. When received from the factory “LiftSync” is set in the “OFF” position for independent basket operation.

NOTE: If “LiftSync” is to remain in the “OFF” position to provide independent basket operation for the purpose of frying two individual products simultaneously, the cooking temperature for each product must be at the same temperature. The fryer will use the higher temperature menu item.

The “Product” feature provides the operator with the ability to modify all presets and/or program additional product menu items as required.

Press the Up ▲ or Down ▼ arrow keys to scroll until “Product” appears in the display.

“Item”

ItEr
Product A

The sub-menu provides the operator with the ability to rename an existing programmed product or add a program to one of the blank program keys, i.e., **PRODUCT A** or **PRODUCT B**.

CONTINUED

OPERATING INSTRUCTIONS

DELUXE CONTROL

PROGRAMMING THE CONTROL

“Product”



“Item”



Press and hold any one of the twelve product keys to be programmed or modified.

The product, as currently named, will begin to flash in the display. Press the Right ▶ arrow key. The display will stop flashing.

Press the Right ▶ arrow key. The first letter of the product name will begin to flash. Press the Up ▲ or Down ▼ arrow keys to scroll until the first letter changes as required (**UPPER CASE, LOWER CASE, A NUMBER, OR A BLANK SPACE IS AVAILABLE THROUGH THE SCROLLING PROCESS**). Press the Right ▶ arrow key. The second letter of the product name will begin to flash. Press the Up ▲ or Down ▼ arrow keys to scroll until the second letter is changed as required. Continue this process until the desired name appears. **NOTE: There are 8 spaces available for the product name. ALL 8 spaces must be filled with a letter, number or blank space to complete the setting.**

When the correct name is displayed, press the Right ▶ arrow key to confirm the selection. The named product will start flashing. Press the Up ▲ or Down ▼ arrow key to advance the control to the next setting option for this product as directed on

<i>Time Mod</i>	<i>Cook Time</i>	<i>SetPoint</i>	<i>ShakeTime</i>	<i>Hold Time</i>
-----------------	------------------	-----------------	------------------	------------------

the following pages:

Entry into the Product programming mode allows the operator to program all available product keys. To continue programming additional items, press and hold the next product key  to be programmed and follow the above instructions.

Off

After the final “**Product**” key has been programmed, the left ◀ arrow key must be pressed to completely exit the control programming mode. The control will revert to the “**OFF**” position. To program control features other than *Product*, press and hold the “**PROGRAM**”  key for a period of 5 to 10 seconds from the “**OFF**” position.

Press the Up ▲ or Down ▼ arrow keys and scroll to the program function to be set.

OPERATING INSTRUCTIONS

DELUXE CONTROL

PROGRAMMING THE CONTROL

“Product”

Product

“TimeMod”

TimeMod
OFF

This sub-menu allows the operator to compensate for any drop in oil/shortening temperature as it relates to cooking start time. In the **“ON”** position, the product countdown timer will not start until the oil temperature reaches the set-point temperature. In the **“OFF”** position, the product countdown timer will start as soon as the product key is pressed. This item is set to **“OFF”** at the factory.

Press the Right ▶ arrow key to select **“TimeMod.”** The display will stop flashing. Press the Up ▲ or Down ▼ arrow keys to scroll to the value of **“ON”** or **“OFF.”** When the correct value is displayed, press the Right ▶ arrow key to confirm the setting. The display flashes. Press the Down ▼ arrow key to advance the control to the next setting option.

“CookTime”

CookTime
5:00

This sub-menu allows the operator to adjust a previously programmed cooking time as determined by the operator or as shown on the product chart. The control provides frying time adjustment up to a period of 60 minutes.

Press the right ▶ arrow key to select **“CookTime.”** The previously set programmed cook time or **“0000”** will appear in the display. The display stops flashing. Press the Up ▲ or Down ▼ arrow keys to change the setting. When the correct time appears, press the Right ▶ arrow key to confirm the setting. The display flashes.

Press the Down ▼ arrow key to advance the control to the next setting option.

“SetPoint”

Setpoint

This sub-menu allows the operator to adjust the temperature of the fry-pot oil/shortening as required from the temperatures shown on the product chart. The set-point temperature of the oil/shortening can be adjusted from a range of 250°F to 450°F (121°C to 232°C).

Press the Right ▶ arrow key to enter the program. **DISPLAY STOPS FLASHING** The previously set temperature will appear in the display. Press the Up ▲ or Down ▼ arrow keys to change the setting. When the correct set-point appears, press the Right ▶ arrow key to confirm the setting **DISPLAY FLASHES** Press the Down ▼ arrow key to advance the control to the next setting.

OPERATING INSTRUCTIONS

DELUXE CONTROL

PROGRAMMING THE CONTROL

“Product”

Product

“ShakTime”

OFF
ShakTime

The **“ShakTime”** sub-menu provides the operator with a programmed time period during which the baskets will automatically lift to half the normal raised position so that the operator can shake each basket. When programmed into a product procedure, an alarm will sound to alert the operator at the start of the **“ShakTime”** cycle and will continue until the activated product key is pressed. The amount of **“ShakTime”** can only be programmed up to the maximum amount of frying time allotted to the programmed product.

There is no **“ShakTime”** programmed into any of the products shown on the product chart. The control provides shake time adjustment from **“OFF”** up to a period of 60 minutes. When received from the factory, shake-time will indicate **“OFF”** in the display for all programmed preset items.

Press the Right ▶ arrow key to enter the **“ShakTime”** sub-menu. The display stops flashing. Press the Up ▲ or Down ▼ arrow keys to change the setting. When the desired amount of **“ShakTime”** appears, press the right ▶ arrow key to confirm the setting. If no shake time is required, press the Down ▼ arrow key and scroll until **“OFF”** appears in the display. When the correct setting appears, press the right ▶ arrow key to confirm. The display flashes. Press the down ▼ arrow key to advance the control to the next sub-menu setting.

To exit the control programming mode at any time, press and hold the LEFT ◀ arrow key.

OPERATING INSTRUCTIONS

DELUXE CONTROL

PROGRAMMING THE CONTROL

“Product”

Product

“HoldTime”

1:00
HoldTime

This sub-menu allows the operator to program a time interval to lift the basket(s) and allow the product to drain before signaling the end of the frying cycle. There is no “HoldTime” programmed into any of the products shown on the product chart. The control provides hold time adjustment from “OFF” up to a period of 60 minutes.

Press the Right ▶ arrow key to enter the “HoldTime” sub-menu. The display stops flashing. The previously set hold time or “OFF” will appear in the display. Press the Up ▲ or Down ▼ arrow keys to change the setting. When the correct “HoldTime” appears, press the Right ▶ arrow key to confirm the setting. If no hold time is required, press the Down ▼ arrow key and scroll until “OFF” appears in the display. When the correct setting appears, press the Right ▶ arrow key to confirm. The display flashes.

Entry into the Product programming mode allows the operator to program all available product keys. After the final “Product” key has been programmed, the LEFT ◀ arrow key must be pressed to completely exit the control programming mode. The control will revert to the “OFF” position.

Off

To program control features other than **PRODUCT**, press and hold the “PROGRAM”  key for a period of 5 to 10 seconds from the “OFF” position. Press the Up ▲ or Down ▼ arrow keys and scroll to the program function to be set.

To exit the control programming mode at any time, press and hold the LEFT ◀ arrow key.

OPERATING INSTRUCTIONS

DELUXE CONTROL

PROGRAMMING THE CONTROL

“BsktLift”



The Basket Lift program provides the operator with the ability to enable or disable the automatic basket lift function. In the “**ON**” position, the baskets will lift automatically as programmed in the selected product procedure. In the “**OFF**” position, both baskets will remain in the raised position until manually dropped by the operator. This function is set in the “**ON**” position as received from the factory. **IT IS STRONGLY URGED THAT THE “BSKTLIFT” REMAIN AT THIS SETTING.** If it is ever necessary to transition from the disabled “**OFF**” position to the enabled “**ON**” position, the control display will indicate “**POWERDOWN**” requiring the operator to perform a control shutdown in order to synchronize the baskets with the revised state of the control.

Turn the Master Power Switch (located behind the front access door) to the “**OFF**” position.

Press the Up ▲ or Down ▼ arrow keys to scroll until “**BsktLift**” appears in the display. Press the Right ► arrow key to enter the program. **DISPLAY STOPS FLASHING** The previous setting will appear in the display. Press the Up ▲ or Down ▼ arrow keys to change the setting. When the correct setting appears, press the Right ► arrow key to confirm. **DISPLAY FLASHES** Press the Down ▼ arrow key to advance the control to the next setting option.

“LiftSync”

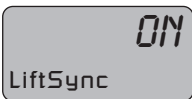

AVAILABLE ON DUAL-CONTROL FRYERS ONLY. The “**LiftSync**” program provides the ability to raise both basket lifts simultaneously by selecting the “**ON**” position. The factory preset is in the “**OFF**” position for independent operation.

Press the Up ▲ or Down ▼ arrow keys to scroll until “**LiftSync**” appears in the display. Press the Right ► arrow key to enter the program. **DISPLAY STOPS FLASHING** Press the Up ▲ and Down ▼ arrow keys to toggle between “**ON**” and “**OFF**.” When the selection has been made, press the Right ► arrow key to confirm the selection. **DISPLAY FLASHES** Press the Down ▼ arrow key to advance the control to the next programming function.

“Temp F/C”

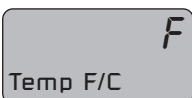

The temperature display can be shown in degrees Fahrenheit or Celsius.

Press the Up ▲ or Down ▼ arrow keys to scroll until “**Temp F/C**” appears in the display. Press the Right ► arrow key to enter the program. **DISPLAY STOPS FLASHING** The current setting will appear in the display. Press the Up ▲ or Down ▼ arrow keys to toggle between “**F**” and “**C**.” Press the Right ► arrow key to accept the desired selection. **DISPLAY FLASHES** Press the Down ▼ arrow key to advance the control to the next programming function.

To exit the control programming mode at any time, press and hold the LEFT ◀ arrow key.

OPERATING INSTRUCTIONS

DELUXE CONTROL

PROGRAMMING THE CONTROL

“Language”

The language option is only available in English “**ENG**” at this time.

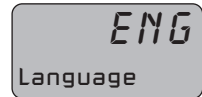

“TempDisp”



The operator can choose to have the fryer oil temperature continuously shown in the display during a product cooking sequence by selecting “**ON**” or to a normal display sequence by selecting “**OFF.**” The function is set to “**ON**” at the factory.

Press the Up ▲ or Down ▼ arrow keys to scroll until “**TempDisp**” appears in the display. Press the Right ▶ arrow key to enter the program. **DISPLAY STOPS FLASHING** The current setting of “**ON**” or “**OFF**” will appear in the display. Press the Up ▲ or Down ▼ arrow keys to change the setting. When the correct setting appears, press the Right ▶ arrow key to confirm the setting. **DISPLAY FLASHES** Press the Down ▼ arrow key to advance the control to the next programming function.

“AlarmSet”



The operator is able to set the volume of the fryer alarm to off, low, medium or high “**OFF**”, “**LO**”, “**MED**” or “**HI.**” The alarm is set to “**HI**” when received from the factory.

Press the Up ▲ or Down ▼ arrow keys to scroll until “**AlarmSet**” appears in the display. Press the Right ▶ arrow key to enter the program. **DISPLAY STOPS FLASHING** The current setting will appear in the display. Press the Up ▲ or Down ▼ arrow keys to toggle among the available choices. When the correct setting appears, press the Right ▶ arrow key to confirm the setting. **DISPLAY FLASHES** Press the Down ▼ arrow key to advance the control to the next programming function.

“IdleMode”

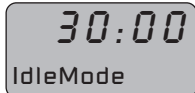

The idle mode allows the operator to set a period of time during which the fryer is not being used but still maintains full fryer oil temperature. When idle time expires, the fryer oil temperature will drop to 250°F (121°C) at which point the oil/shortening must be reheated before frying additional product. This time period can be adjusted between “**OFF**” and **60:00** minutes. The factory default is set at 30 minutes idle time.

Press the Up ▲ or Down ▼ arrow keys to scroll until “**IdleMode**” appears in the display. Press the Right ▶ arrow key to enter the program. **DISPLAY STOPS FLASHING** If no idle time is required, press the Down ▼ arrow key until “**OFF**” appears in the display. Press the Up ▲ or Down ▼ arrow keys to change the setting. When the correct setting appears, press the Right ▶ arrow key to confirm. **DISPLAY FLASHES** Press the Down ▼ arrow key to advance the control to the next programming function.



“IdleMode” can be interrupted at any time by pressing any of the 12 product preset keys. The fryer will immediately begin to preheat to set-point temperature. The baskets can be dropped only after the set-point temperature has been reached.

To exit the control programming mode at any time, press and hold the LEFT ◀ arrow key.

OPERATING INSTRUCTIONS

DELUXE CONTROL

PROGRAMMING THE CONTROL

"FILTER"

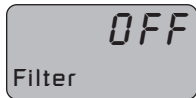

The filter program is a monitor to notify the operator to service the oil/shortening after a specified number of product loads established and set in the filter count **"FILTER CNT"** programming function. This feature is set to **"OFF"** at the factory. **THE NUMBER OF PRODUCT LOADS CAN BE ADJUSTED BY THE OPERATOR THROUGH THE FILTER COUNT PROGRAM. FILTER COUNT WILL AUTOMATICALLY ADJUST FILTER MONITOR ALERTS TO ONE OF THE THREE SELECTIONS SHOWN AS SET BY THE OPERATOR.**

"Off"

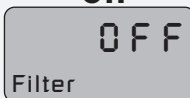

When set to the **"OFF"** position, the filter monitor is disabled and will **NOT** notify the operator to service the oil/shortening.

"ALRM"



Set to alarm **"ALRM,"** this feature will provide an audible alarm and the display will indicate "FILTER NOW" as a reminder to the operator after every 15 product loads or the number of processed fry loads set by the operator in the **"FILTER CNT"** program function. When set to **"ALRM"** additional fry loads can be processed and the alarm can be silenced by pressing the **"ON/OFF"** power key on the main control panel to the **"OFF"** position

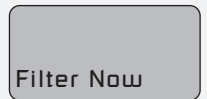

"Loch"



When the program mode is changed to the lock **"LOCH"** position, an audible alarm will sound and the fryer will become inoperable following the number of processed fry loads set by the operator in the **"FILTER CNT"** program function. The control will only become operable after the oil/shortening has been serviced.

Press the Up ▲ or Down ▼ arrow keys to scroll until **"FILTER"** appears in the display. Press the Right ► arrow key to enter the program. The display stops flashing. Press the Up ▲ or Down ▼ arrow keys to toggle among the available choices. When the desired setting appears, press the Right ► arrow key to accept the selection. The display flashes. Press the Down ▼ arrow key to advance the control to the next programming function.

To exit the control programming mode at any time, press and hold the LEFT ◀ arrow key.

OPERATING INSTRUCTIONS

DELUXE CONTROL

PROGRAMMING THE CONTROL

“FILTER CNT”

15
Filter Cnt

The filter count program allows the operator to change the number of processed fry loads within a range of 5 to 15 before the monitor notifies the operator to service the oil/shortening. The factory default is set at 15 loads. **THE “FILTER” MONITOR PROGRAM MUST BE ACTIVATED IN ORDER TO MAKE THE “FILTER CNT” PROGRAM FUNCTIONAL.**

Press the Up ▲ or Down ▼ arrow keys to scroll until **“FILTER CNT”** appears in the display. Press the Right ► arrow key to enter the program. The display stops flashing. Press the Up ▲ or Down ▼ arrow keys to until the desired number of processed loads appears in the display. When the desired setting appears, press the Right ► arrow key to accept the selection. The display flashes. Press the Down ▼ arrow key to advance the control to the next programming function.

“MAX TIME”

3:00
Max Time

“MAX TIME” provides notification when the temperature of the oil is lower than the set-point temperature. The factory set default is 3 minutes and should not be adjusted by the operator. Press the Down ▼ arrow key to advance the control to the next programming function.

LoTemp

“HI TEMP”

450°F
Hi Temp

“HI TEMP” allows the operator to trigger an automatic fryer shut-down at a specified oil temperature within a range of 250°F to 450°F (121°C to 232°C). This safety feature is provided in the event the actual oil temperature exceeds the oil set-point temperature due to equipment malfunction. The factory default is set at 450°F (232°C).

HOT

Press the Up ▲ or Down ▼ arrow keys to scroll until **“HI TEMP”** appears in the display. Press the Right ► arrow key to enter the program. The display stops flashing. Press the Up ▲ or Down ▼ arrow keys to scroll until the desired shut-down temperature appears in the display. When the desired temperature appears, press the Right ► arrow key to accept the selection. Press the Down ▼ arrow key to advance the control to the next programming function.

OPERATING INSTRUCTIONS

DELUXE CONTROL

PROGRAMMING THE CONTROL

“LO BAND”

21°F
Lo Band

“LO BAND” provides an alarm notification when the temperature of the oil is lower than the set-point temperature. The adjustment range is between 5°F and 100°F (3°C and 56°C) with a factory preset of 21°F (12°C).

Low Temp

Press the Up ▲ or Down ▼ arrow keys to scroll until “LO BAND” appears in the display. Press the Right ► arrow key to enter the program. The display stops flashing. Press the Up ▲ or Down ▼ arrow keys to scroll until the desired number appears in the display. When the desired setting appears, press the Right ► arrow key to accept the selection. The display flashes. Press the Down ▼ arrow key to advance the control to the next programming function.

“HI BAND”

25°F
Hi Band

“HI BAND” provides an alarm notification when the temperature of the oil becomes higher than the set-point temperature. The adjustment range is between zero and 100°F (38°C) with a factory preset of 25°F (14°C).

Hi Temp

Press the Up ▲ or Down ▼ arrow keys to scroll until “HI BAND” appears in the display. Press the Right ► arrow key to enter the program. The display stops flashing. Press the Up ▲ or Down ▼ arrow keys to scroll until the desired number appears in the display. When the desired setting appears, press the Right ► arrow key to accept the selection. The display flashes. Press the Down ▼ arrow key to advance the control to the next programming function.

“MELT CT”

0:10
Melt Ct

The fryer control includes a melt function with ON/OFF pulsed heating cycles for the purpose of melting solid shortening at a continuous but slower rate to assure full melt-down. The operator has the ability to control the ON/OFF pulse rate between 00:01 and 00:60 seconds. The factory default is set for 10 seconds (00:10).

Press the Up ▲ or Down ▼ arrow keys to scroll until “MELT CT” appears in the display. Press the Right ► arrow key to enter the program. The display stops flashing. Press the Up ▲ or Down ▼ arrow keys to scroll until the desired time appears in the display. When the desired setting appears, press the Right ► arrow key to accept the selection. The display flashes. Press the Down ▼ arrow key to advance the control to the next programming function.

“PREHEAT BAND”

10°F
Preheat Band

The “PREHEAT BAND” is used to prevent the oil temperature in the frypot from reaching the actual set-point temperature in order to compensate for temperature override as the fryer calls for heat. This program feature is set to 10°F (6°C) at the factory.

It is strongly urged that the “PREHEAT BAND” remain at this setting.

To exit the control programming mode, press and hold the LEFT ◀ arrow key.

OPERATING INSTRUCTIONS

DELUXE CONTROL

TEMPERATURE VERIFICATION



The temperature of the cooking oil/shortening and the temperature set-point can be verified at any time.

Press the **“Temperature”** key once to verify the temperature of the oil/shortening.

Press the **“Temperature”** key twice to verify the set-point temperature.

The fryer control will automatically exit either of these readings after four (4) seconds.

If a defective probe is suspected, measure the temperature of the oil/shortening with a thermometer. Compare the thermometer reading with temperature shown in the control to make certain the readings are reasonably close. If there is a wide discrepancy, perform a complete fryer shutdown and contact Alto-Shaam service.

ERROR CODE DISPLAY MESSAGES		
PROBABLE CAUSE		SOLUTION
<div style="border: 1px solid black; padding: 5px; display: inline-block;"> E-01 Ambient </div> Ambient temperature surrounding the controller is too high or too low.		Adjust the system or the environment so that the ambient air surrounding the control is above 32°F (0°C) or below 160°F (80°C).
<div style="border: 1px solid black; padding: 5px; display: inline-block;"> E-02 Defaults </div> Controller EEPROM initialization (FIRST TIME USE).		Wait for approximately 30 to 120 seconds. If the message does not terminate, return the controller to the factory.
<div style="border: 1px solid black; padding: 5px; display: inline-block;"> E-10 FixProbe </div> Probe shorted.		Contact Alto-Shaam service.
<div style="border: 1px solid black; padding: 5px; display: inline-block;"> E-20 FixProbe </div> Probe open.		Contact Alto-Shaam service.
<div style="border: 1px solid black; padding: 5px; display: inline-block;"> E-30 LowTemp </div> Exceeded maximum amount of time to achieve temperature.		Turn power “OFF” and reset the control.
<div style="border: 1px solid black; padding: 5px; display: inline-block;"> E-31 HiTemp </div> Exceeded set temperature by X degrees.		Turn power “OFF” and allow fryer to cool. Contact Alto-Shaam service.
<div style="border: 1px solid black; padding: 5px; display: inline-block;"> E-86 Service </div> Preset Data Error (EEPROM date error)		Contact Alto-Shaam service.
<div style="border: 1px solid black; padding: 5px; display: inline-block;"> NOCOMMS Service </div> Problem with connectors or cable.		Check ribbon cable from main board to slave board. Contact Alto-Shaam service.

OPERATING INSTRUCTIONS

DELUXE CONTROL

TEMPERATURE VERIFICATION (CONTINUED)

1. Press and hold the **ON/OFF** key for 1 second.

⇒ One of the following will appear in the alpha/numeric display:

- A. **“READY”** along with “- - - -” in the L.E.D. display.
The fryer is in the cooking range.
NOTE: For best results, do not cook product until the display is in this mode.
- B. **“HI TEMP”**
The pot temperature is 40°F (4°C) or higher than the set-point.
- C. **“LO TEMP”**
The pot temperature is 21°F (-6°C) or lower than the set-point.
- D. **“PROBLEM”**
Indicates a heating problem.
- E. **“HOT”**
The pot temperature is more than 410°F (210°C) or 395°F (202°C) for CE (European Community fryers).
- F. **“FIXPROBE”**
The control has detected a problem in the temperature measuring circuit, including the probe.
NOTE: A decimal point “.” between L.E.D. digits 1 and 2 in either display indicates the control is calling for heat.



OPERATING INSTRUCTIONS

DELUXE CONTROL

OIL/SHORTENING FILTRATION

Careful observation of the finished food product will help determine optimal filtering frequency. Filtering the cooking oil at regular intervals will help ensure food quality.

FOR BEST RESULTS: Do not allow the temperature of the oil to decrease below the “Idle Mode” temperature of 250°F (121°C) when filtering.

**CAUTION**

Operators must be made aware of the hazards involved in the operation of a hot oil filtering system. On-site supervision during the filtration process and the cleaning process is strongly recommended.

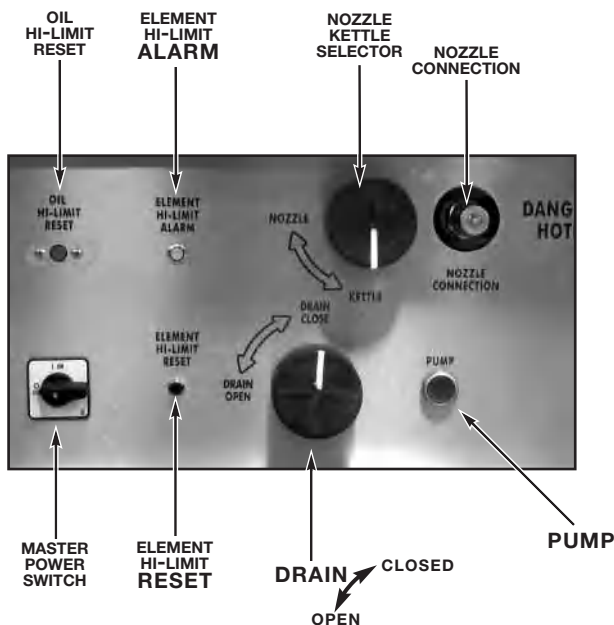

1. Open the front access door. With the Kettle/Nozzle selector in the “**KETTLE**” position, rotate the drain valve counterclockwise until rotation stops and the drain valve is in the “**OPEN**” position. Power to the main control panel will automatically switch “**OFF.**”
2. Allow contents of the fryer to completely drain.
3. Press the **PUMP “ON”** to allow the oil to circulate through the drain system to flush crumbs. Using the brushes provided, brush the sides and bottom of the fryer while the oil is circulating through the system. Use the angle brush under the heat exchangers.
4. Press the **PUMP “OFF”** and allow contents of the fryer to completely drain.
5. Rotate the drain valve clockwise to the “**CLOSED**” position.
6. Press the **PUMP “ON”** and allow the fryer to refill to the recommended level adding additional oil/shortening as required to maintain proper fill level.
7. After the frypot has completely refilled, pull out the mobile oil trolley and discard the filter into a proper receptacle. Clean the filter assembly and oil trolley, if needed.
8. Replace the oil filter and return the trolley to the proper position beneath the fryer.
9. Press and hold the “**ON/OFF**” key on the main control panel for 1-1/2 to 2 seconds to energize the fryer. Continue normal fryer operation after the preheat function has been completed.



**CAUTION**

 HOT SHORTENING AND SURROUNDING METAL SURFACES BECOME EXTREMELY HOT. TO AVOID BURNS, ALWAYS USE HAND PROTECTION WHEN POURING OIL OR ADDING SHORTENING INTO THE FRYPOT. CONTINUALLY GUARD AGAINST HOT SPLASHING OIL.

**WARNING**

 TO AVOID PERSONAL INJURY, USE CAUTION WHEN SURFACES BECOME SLIPPERY DUE TO SPILLED OR DRIPPING OIL.

OPERATING INSTRUCTIONS

DELUXE CONTROL

FILTER REPLACEMENT

1. With the **DRAIN** in the “**CLOSED**” position, pull the trolley from the fryer and disconnect the hose from the fryer.

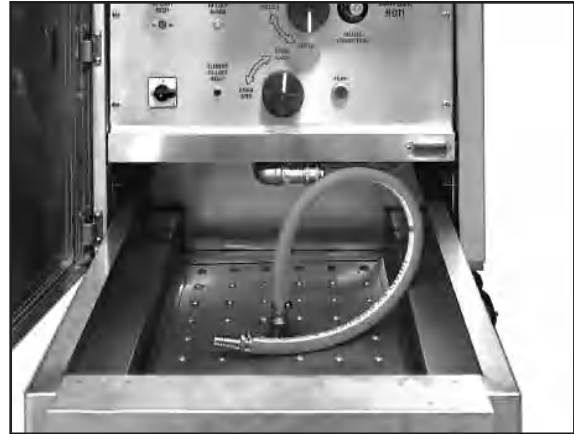

2. Pushing down on filter frame **3** clip, pull side of filter cartridge **1** closest to clip upwards. Slide opposite edge of filter cartridge out from beneath the filter frame lip.
3. Remove and discard used filter **2**.
4. Place new filter next to screen on underside of filter cartridge **1** and reverse step 2 above.
5. Reconnect hose to fryer and return trolley to the full position under the fryer.

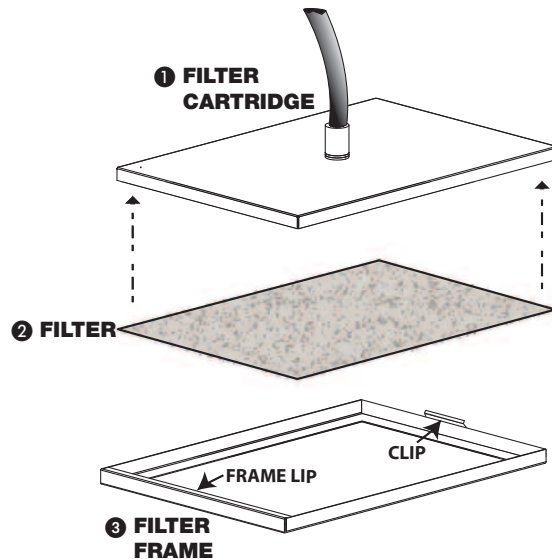

STANDARD AND OPTIONAL FILTERS	
PART NO.	DESCRIPTION
FI-27791	PAPER (STANDARD WITH FRYER) 7-count package
FI-27794	PAPER (STANDARD WITH FRYER) 100-count package
FI-27648	CHARCOAL/CARBON FILTER 30-count pkg.
FI-27014	REUSABLE MESH FILTER, single

OPERATING INSTRUCTIONS

DELUXE CONTROL

FILTER CLEANING & MAINTENANCE

NOTE: Make certain to use hand protection when working with hot surfaces.

REUSABLE MESH FILTER OPTION:

Clean the reusable mesh filter (**FI-27014**) by spraying thoroughly with hot water. **DO NOT** clean in the dishwasher. **DO NOT** use detergents to clean. Detergents and detergent residues will significantly reduce the life of oil and shortening products.

To discard deteriorated oil/shortening, the trolley can be pulled from the fryer and can be rolled to a convenient location for use with a pumping device.

ALWAYS MAKE CERTAIN THE TROLLEY IS PROPERLY POSITIONED BENEATH THE FRYER BEFORE OPERATION.

CAUTION

A WORN FILTER WILL AFFECT PRODUCT FRYING RESULTS.

Make certain the filter is performing efficiently by inspecting the filter each time it is cleaned. Examine for cuts and holes. For the best results, replace the filter whenever necessary.



CAUTION

TO PREVENT FILTER DAMAGE, DO NOT USE SHARP IMPLEMENTS TO REMOVE SCRAPS FROM THE FILTER.

Make certain the filter is securely fastened to the support basket before returning the assembly to the trolley.

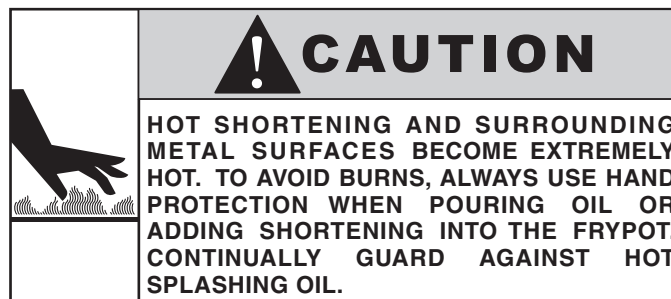

OPERATING INSTRUCTIONS

DELUXE CONTROL

CLEANING & MAINTENANCE

OIL DISCARD HOSE OPTION:

The oil discard hose option (HO-27686) is available as an option to assist both the boil-out and filtration operation.

With the discard hose attached to the nozzle connection, place the Kettle/Nozzle selector in the **"NOZZLE"** position.

The drain can be placed in the **"OPEN"** or **"CLOSED"** position as required.

Disconnect hose following use and return the selector to the **"KETTLE"** position.

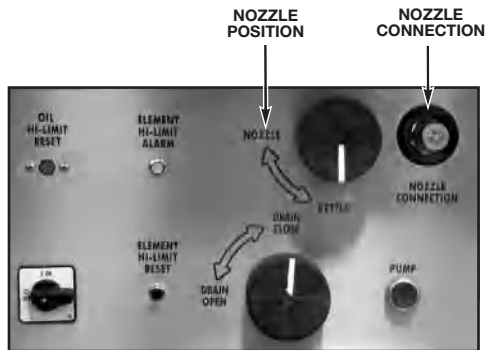

Nozzle will contain a small amount of oil after use. Dispose of properly.



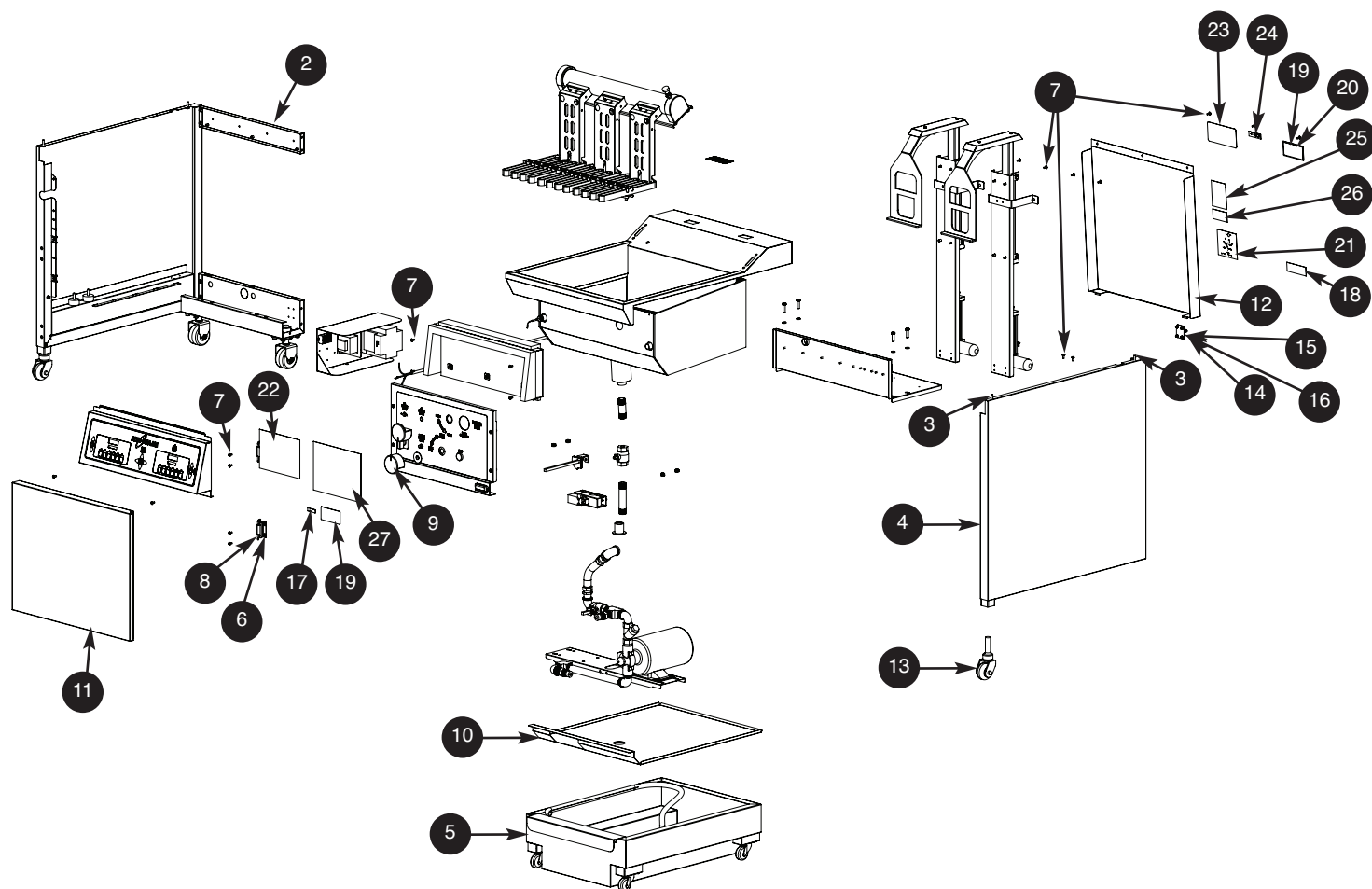

LOC	PART NO	DESCRIPTION	QTY	UNIT	LOC	PART NO	DESCRIPTION	QTY	UNIT
2	5004621	WELDMNT, LEFT SIDE PANEL,	1	EA	15	SC-23670	SCREW,10-32X1/2,NF PHIL,FLAT,	4	EA
3	SC-24262	1/4-20 X 5/8" SER FGD HD ZP	4	EA	16	NU-2215	NUT,10-32,NF HEX MS,#18-8 S/S	4	EA
4	5004622	ASSY, SUB, SIDE PANEL, RIGHT	1	EA	17	LA-22376	MADE IN USA LABEL	1	EA
5	5006236	ASSY-FAT DRAWER	1	EA	18	LA-24537	LABEL, 2" INSTALL	1	EA
6	HG-27687	HINGE, FRAME LEAF	2	EA	19	LA-26348	RATING TAG LABEL	2	EA
7	SC-2661	SCREW,10-32 X1/2,NF PHIL TRUSS M/S	21	EA	20	LA-26349	LAMINATE LABEL PROTECTOR	1	EA
8	PI-27689	PIN, HINGE	2	EA	21	LA-2637	CART INSTALLATION LABEL	1	EA
9	KN-34239	KNOB, DRAIN	2	EA	22	LA-27397	LABEL-START UP PROCEDURE	1	EA
10	1006485	SPLASH GUARD-ELECTRIC	1	EA	23	LA-27428	LABEL, FORKLIFT ATTENTION	1	EA
11	5005801	DOOR, FRYER	1	EA	24	LA-3085	DISCONNECT POWER	1	EA
12	1006436	BACK ACCESS PANEL	1	EA	25	LA-34435	LABEL-FUSE WARNING	1	EA
13	CS-27547	CASTER, ADJ. NON-SWIVEL FRNT	1	EA	26	LA-34436	LABEL-TRANSFORMER FUSE	1	EA
14	BT-26884	BRACKET, TETHER	1	EA	27		SCHEMATIC, ELEC.	1	EA

SERVICE



ELEMENT HIGH LIMIT
LL-34378

ELEMENT

	HEATER 1	HEATER 2	HEATER 3
220/208V -	EL-34387	EL-34352	EL-34352
240V -	EL-34388	EL-34353	EL-34353
415V -	EL-34389	EL-34385	EL-34385
440/480V -	EL-34389	EL-34354	EL-34354

TEMPERATURE PROBE
5005200



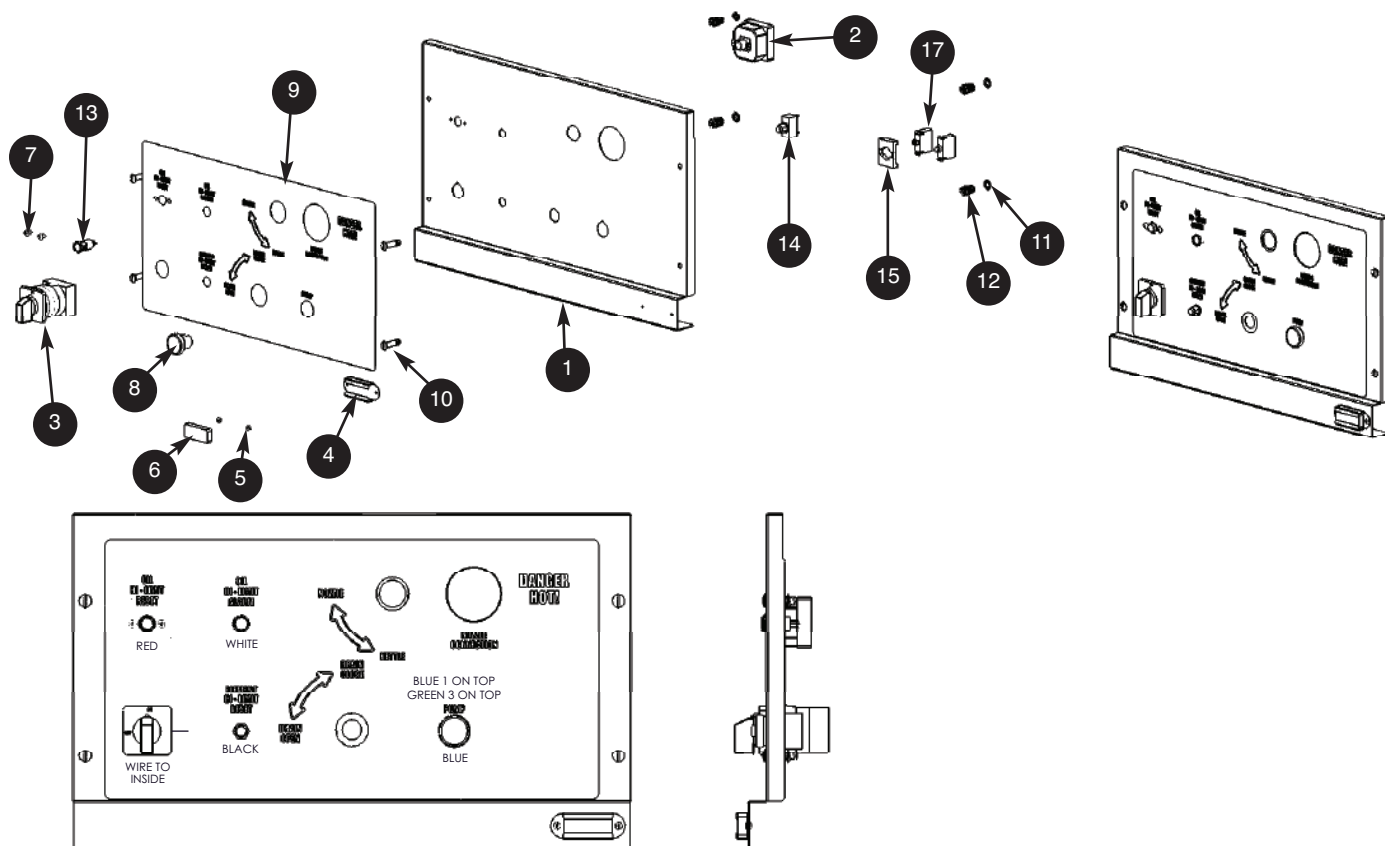

LOC	PART NO	DESCRIPTION	QTY	UNIT
1	1006572	CONTROL PANEL,MIDDLE	1	EA
2	TT-34245	THERMOSTAT, HI-LIMIT	1	EA
3	SW-34254	SWITCH, CAM, FOR SINGLE PHASE	1	EA
4	1006303	BRACKET-MAGNET	1	EA
5	RI-2097	#42 STAINLESS RIVET	2	EA
6	MA-27568	MAGNET-SMCO	1	EA
7	SC-22271	SCREW, PAN HEAD M4 X 7MM	2	EA
8	SW-34240	PUSHBUTTON SWITCH-PUMP	1	EA
9	PE-27762	OVERLAY-GAS CONTROL PANEL	1	EA

LOC	PART NO	DESCRIPTION	QTY	UNIT
10	ST-22193	STUD,CT M6 X 27 MM, 1/4 TURN	4	EA
11	WS-22195	WASHER, SAFETY, STEEL	4	EA
12	SD-22194	SPRING, CT M6 X 48, SAFTY	4	EA
13	LI-3951	WHITE PILOT LIGHT 250V	1	EA
14	SW-33495	SWITCH-PUSH BUTTON SPST	1	EA
15	PA-27057	PLATE-LIGHT MOUNTING	1	EA
17	LI-34251	SWITCH-PUSHBUTTON	1	EA
NOT SHOWN:				
	LI-34252	LIGHT-PUMP PUSHBUTTON	1	EA

SERVICE

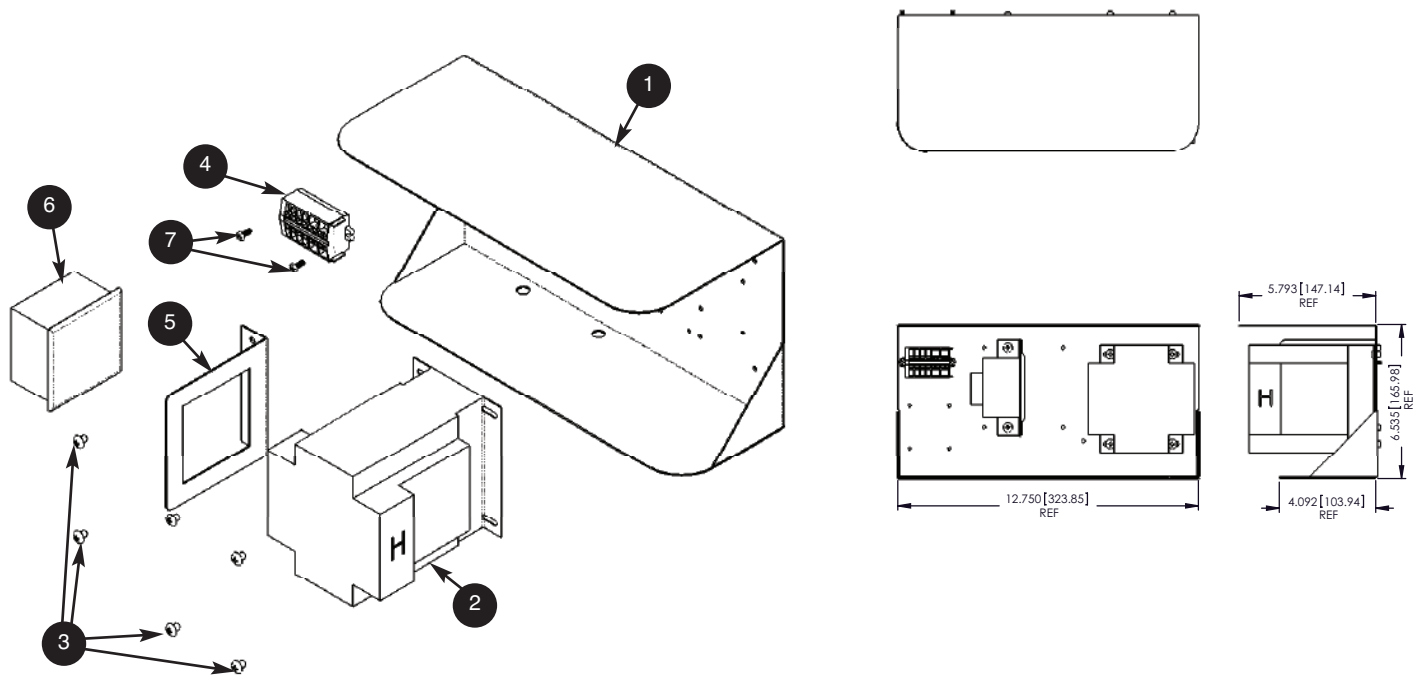

LOC	PART NO	DESCRIPTION	QTY	UNIT
1	1005853	BRACKET, BURNER CONTROL,	1	EA
2	TN-34272	TRANSFORMER, 120V/240V-24V,150VA	1	EA
3	SC-2459	8-32 X 1/4" PHIL SCREW	6	EA
4	BK-34372	T-BLOCK, MODULAR	1	EA
5	1006917	BRACKET, HI-LIMIT CONTROLLER	1	EA
6	CC-34378	CONTROLLER, HI-LIMIT,	1	EA
7	SC-23455	6-32 X 3/8 RD HD	2	EA

PART NO	DESCRIPTION	QTY	UNIT
NOT SHOWN:			
CD-34380	CORD, SOOW 16 GA, 3 COND.	3	FT
CR-3226	CONNECTOR,TERM.,#10 STUD RING	1	EA
5005279	WIRE SET	1	EA
FU-34274	FUSE-4A SECONDARY, 3AG TYPE	1	EA
FU-34355	FUSE-2A 250V, T-LAG, GLS, MOL	1	EA



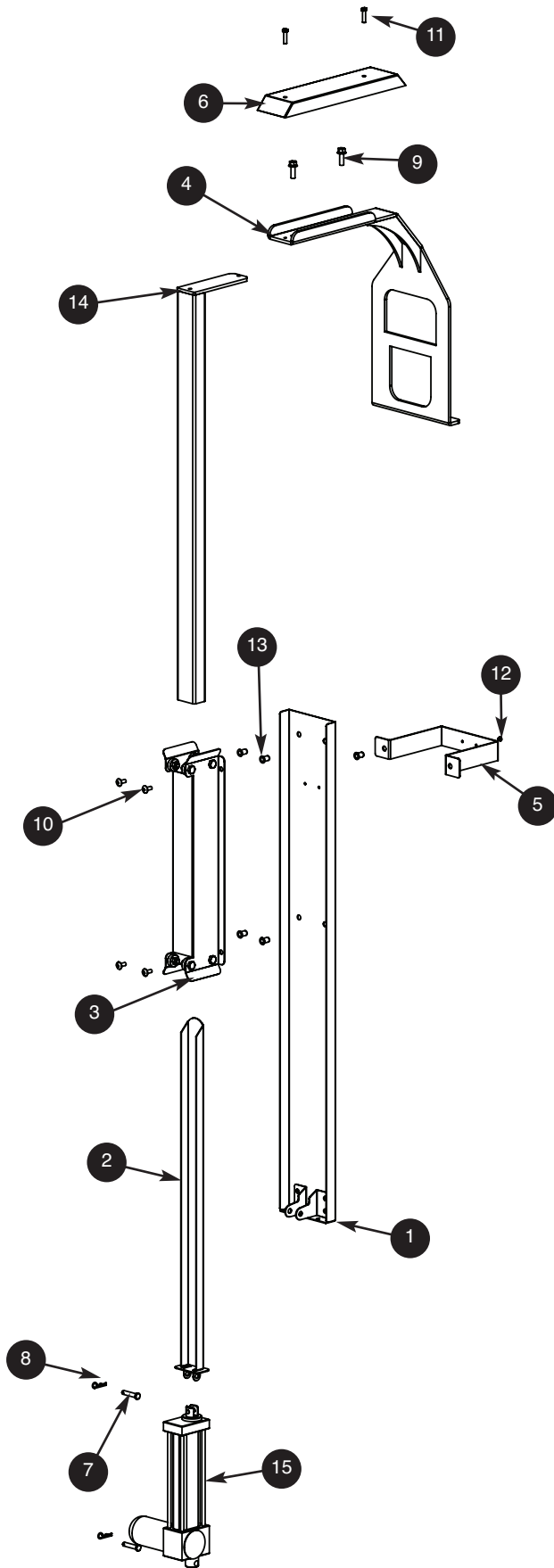

LOC	PART NO	DESCRIPTION	QTY	UNIT
1	5005602	WELDMENT,GIMBAL LIFT HOLDER	1	EA
2	5004478	WELDMENT, LIFT GUIDE	1	EA
3	5004477	GUIDE COLUMN	1	EA
4	HL-27246	WELDMENT, HOLDER, GAS FRYER	1	EA
5	1005565	GIMBAL LIFT	1	EA
6	1005566	GUARD, LIFT	1	EA
7	PI-27539	PIN-CLEVIS	2	EA
8	PI-27540	PIN-COTTER	2	EA
9	SC-25286	1/4-20 X 3/4" FLANGED HD	2	EA
10	SC-2661	SCREW,10-32 X1/2,NF PHIL TRUSS M/S	4	EA
11	SC-23151	10-32 X 3/4" HEX HD SCREW	2	EA
12	RI-2097	#42 STAINLESS RIVET	2	EA
13	HG-22672	10-32 THREADED INSERT	6	EA
14	RD-27821	WELDMENT, LIFT ROD,	1	EA
15	MO-27011	LIFT MOTOR	1	EA

SERVICE

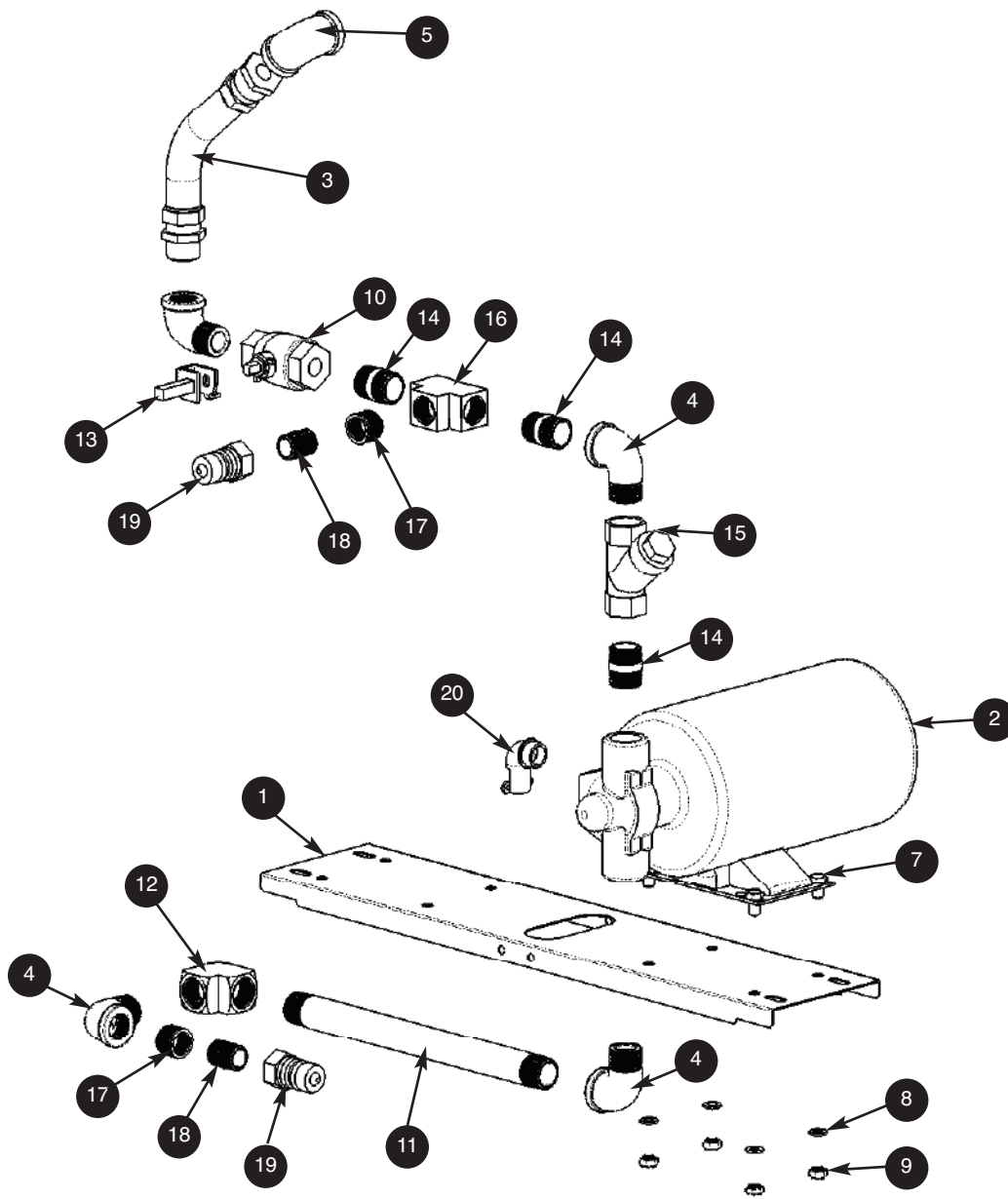

LOC	PART NO	DESCRIPTION	QTY	UNIT	LOC	PART NO	DESCRIPTION	QTY	UNIT
1	1005516	PLATE, PUMP, ASF-75G	1	EA	10	VA-27321	VALVE, DRAIN, 3/4NPT, BALL,	1	EA
2	MO-26835	5E W / S74 MOTOR (FOR 208/220/240/280/415V UNITS)	1	EA	11	NP-27639	3/4" NPT NIPPLE 12" LNG	1	EA
2	MO-34414	MOTOR (FOR 440/480V UNITS)	1	EA	12	EB-27637	90 DEG ELBOW, NPTF, 3/4"	1	EA
3	FT-27023	FELX. STAINLESS STEEL	1	EA	13	5006169	WLDMT, BALL VALVE QD	1	EA
4	EB-27255	ELBOW, 90 STREET, 3/4M X 3/4F	4	EA	14	NP-27640	3/4" NPT 14 NIPPLE X 1.375IN LNG	3	EA
5	EB-27024	ELBOW,.75NPT F X .75NPT F	1	EA	15	VA-27036	BACK PRESSURE VALVE	1	EA
7	SC-26462	HEX HEAD SCREW, M8 X 15	4	EA	16	TE-27636	TEE,S/S, 3/4" X 3/4" X 3/4"	1	EA
8	WS-2867	WASHER, LOCK, 5/16 DIA.	4	EA	17	BU-27836	FACE BUSHING-REDUCING	2	EA
9	NU-22292	M8-1.25, HEX NUT 18-8, DIN #934	4	EA	18	NP-26220	NIPPLE-1/2"-14 NPT	2	EA
					19	FT-28008	FITTING-1/2 NPT X 1/2 QUICK DISCONNECT	2	EA
					20	CR-3292	90 DEG CONNECTOR	1	EA

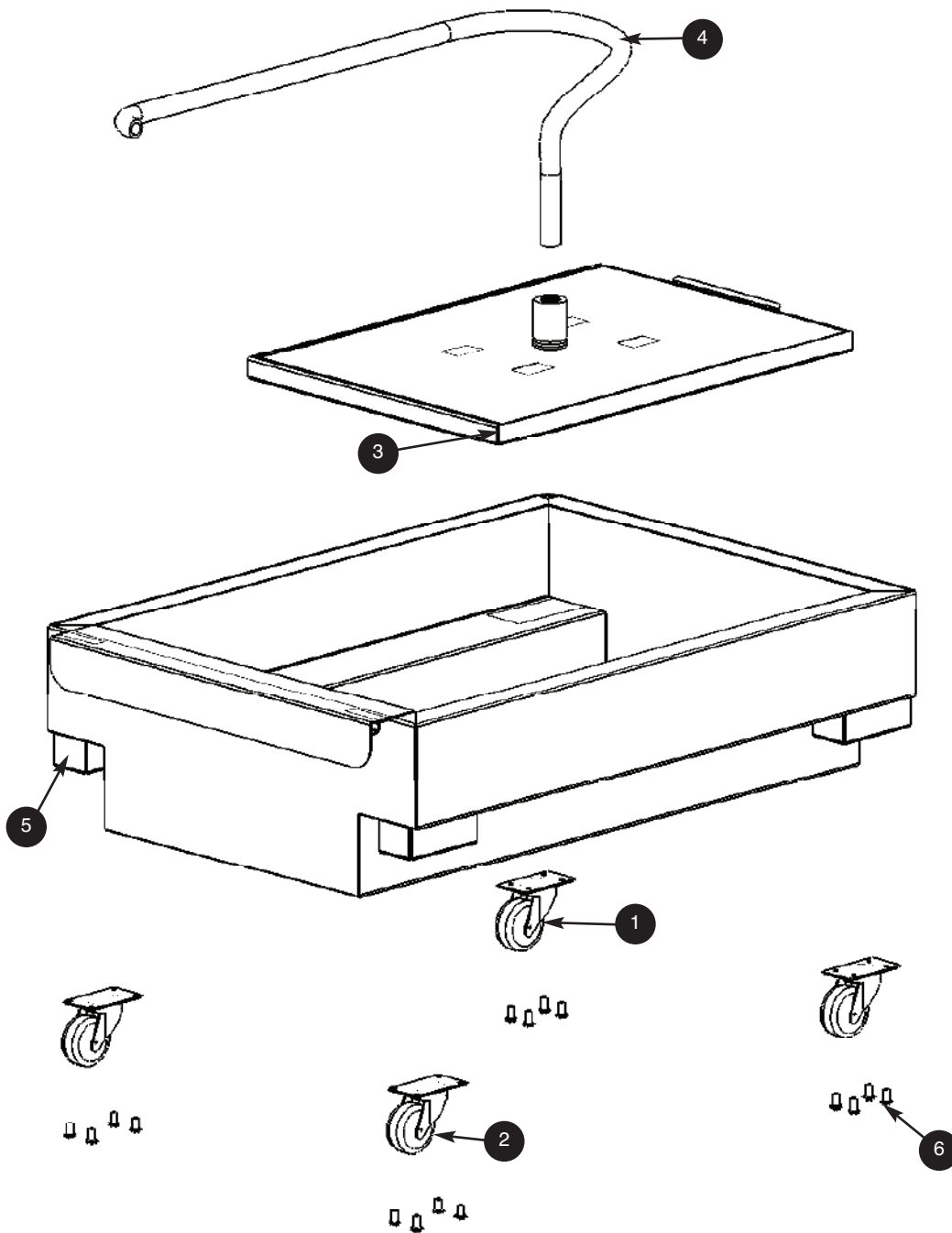

LOC	PART NO	DESCRIPTION	QTY	UNIT
1	CS-27253	CASTER, 2" WHEEL	2	EA
2	CS-27054	CASTER, 2" WHEEL	2	EA
3	5006162	FILTER CARTRIDGE	1	EA
4	HO-27649	HOSE-FILTER	1	EA
5	PN-27701	WLDMT-FAT DRAWER	1	EA
6	SC-2661	SCREW,10-32 X1/2,NF PHIL TRUSS M/S	16	EA

SERVICE

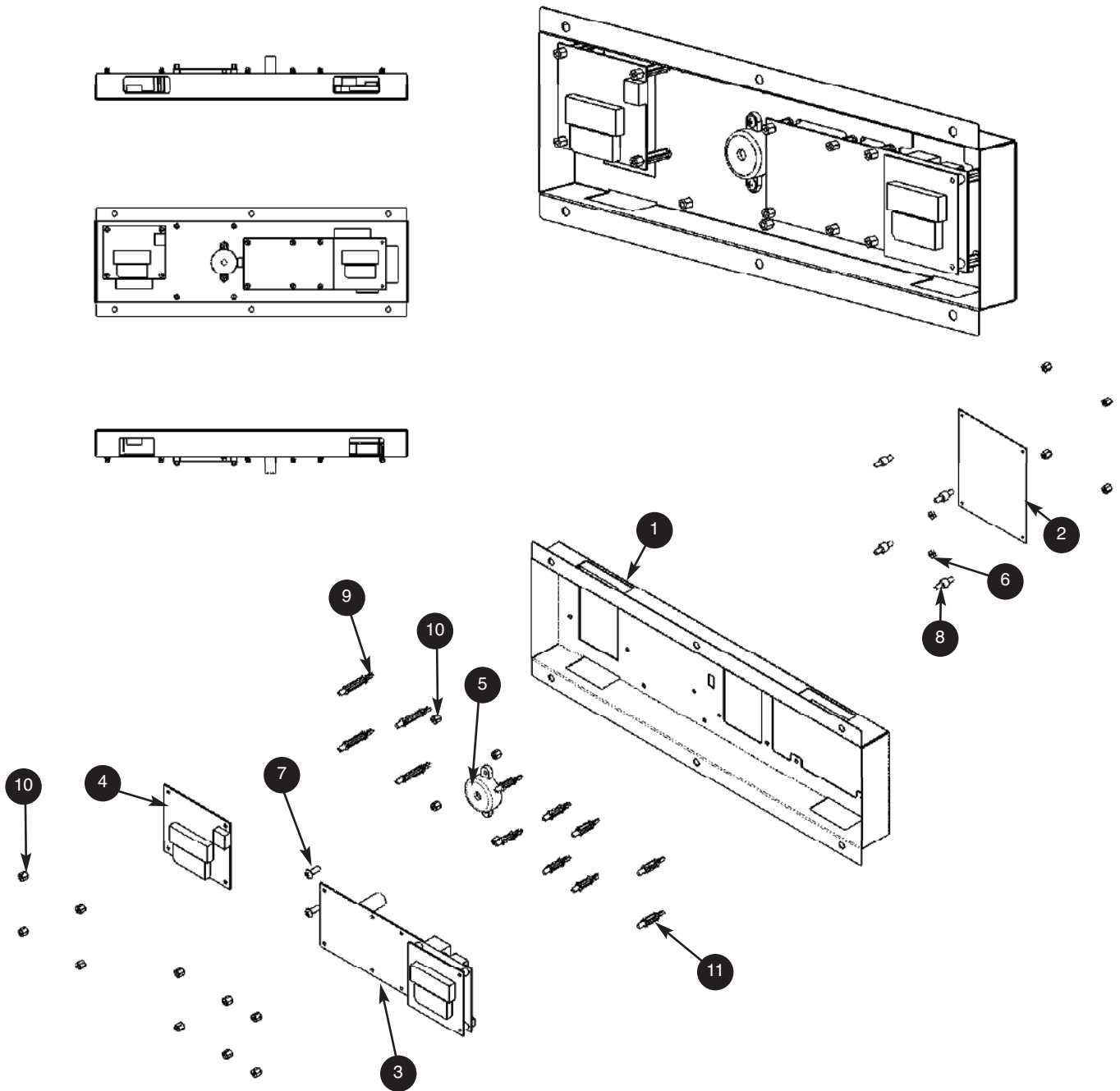

LOC PART NO	DESCRIPTION	QTY	UNIT
1	1005833 FRYER CONTROL BOARD	1	EA
2	BA-34261 CIRCUIT BOARD, MIXED/RELAY	1	EA
3	BA-34439 CIRCUIT BOARD-MASTER POWER	1	EA
4	BA-34440 CIRCUIT BOARD-SLAVE	1	EA
5	BP-3567 BEEPER	1	EA
6	NU-2361 NUT, 6-32 HEX, S/S	2	EA
7	SC-2472 SCREW, 6-32 X 1/2, NC PHIL TRUSS M/S	2	EA

LOC PART NO	DESCRIPTION	QTY	UNIT
8	SC-33706 SCREW, STANDOFF NYLON 6-32 HEX	4	EA
9	SP-27079 SPACER, 1" FOR .125 HOLE IN .062" BOARD	4	EA
10	SP-33707 SPACER, SUPPORT, NYL, 1.4"	18	EA
11	SP-33901 SPACER, 7/16 FOR .125 HOLE IN .062" BOARD	8	EA
NOT SHOWN:			
	CB-34441 CABLE-CONNECTING BLACK	1	EA
	CR-33509 CONNECTOR	1	EA

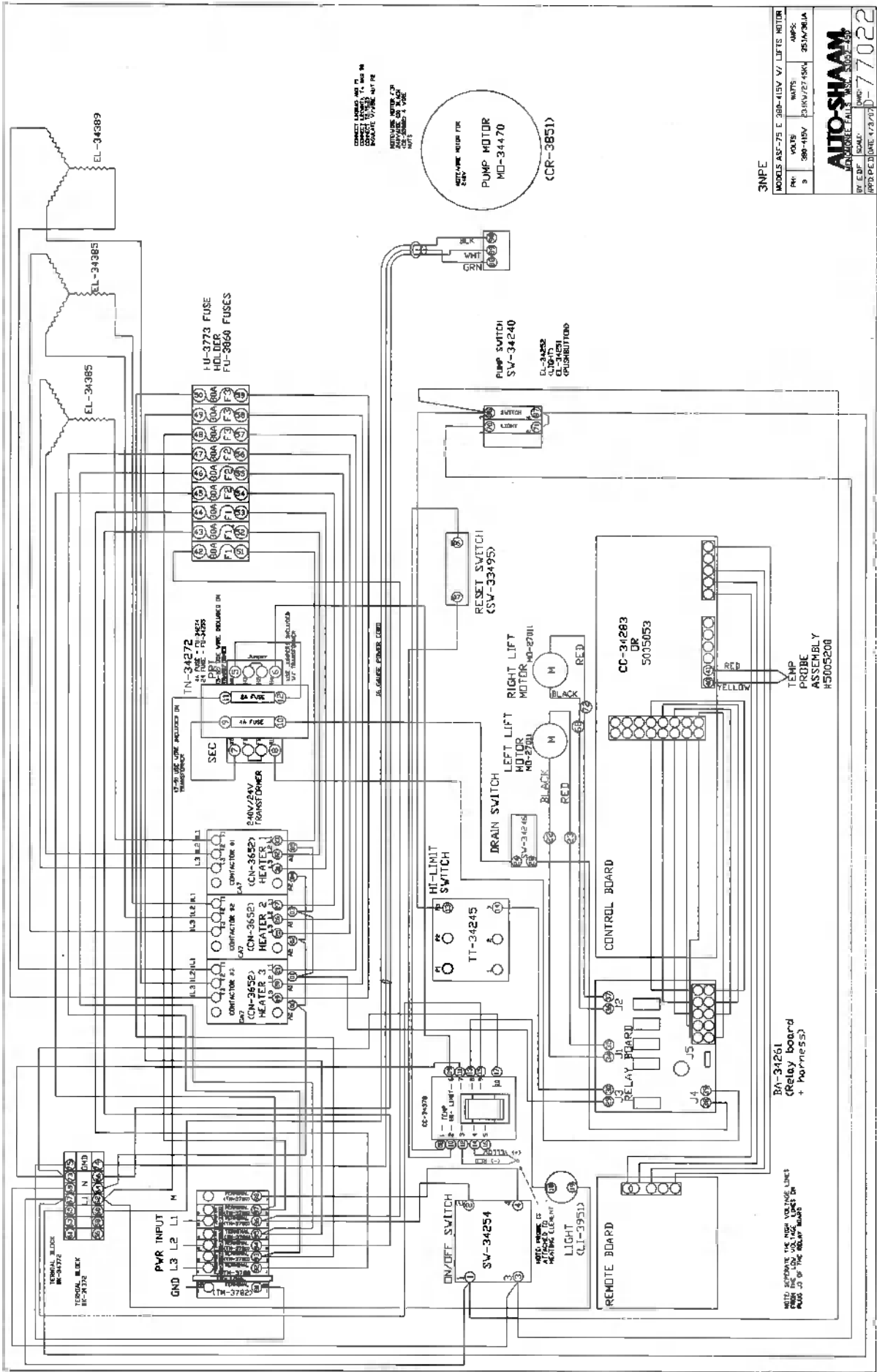

CONNECT LEADS AND PLUG TO MOTOR
 CONNECT TO MOTOR
 ROTATE VOLTAGE MOTOR
 MOTOR
 MOTOR
 MOTOR
 MOTOR

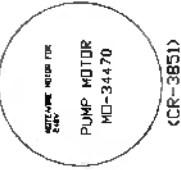

3NPE

MODEL	ASF-75 E	380-415V V1	LEFTS MOTOR
NO.	1	DATE	23/09/27/98
BY	380-415V	SCALE	25/4/2014
APPD	PEJ	DATE	17/3/07

AUTO-SHAAM
 DE WERKplaats van de toekomst
 BY E.D.F. SCALE: 25/4/2014
 APPD PEJ DATE: 17/3/07

BA-34261
 (Relay board
 + harness)

NOTE: REFER TO THE HIGH VOLTAGE LINES
 PART OF THE RELAY BOARD

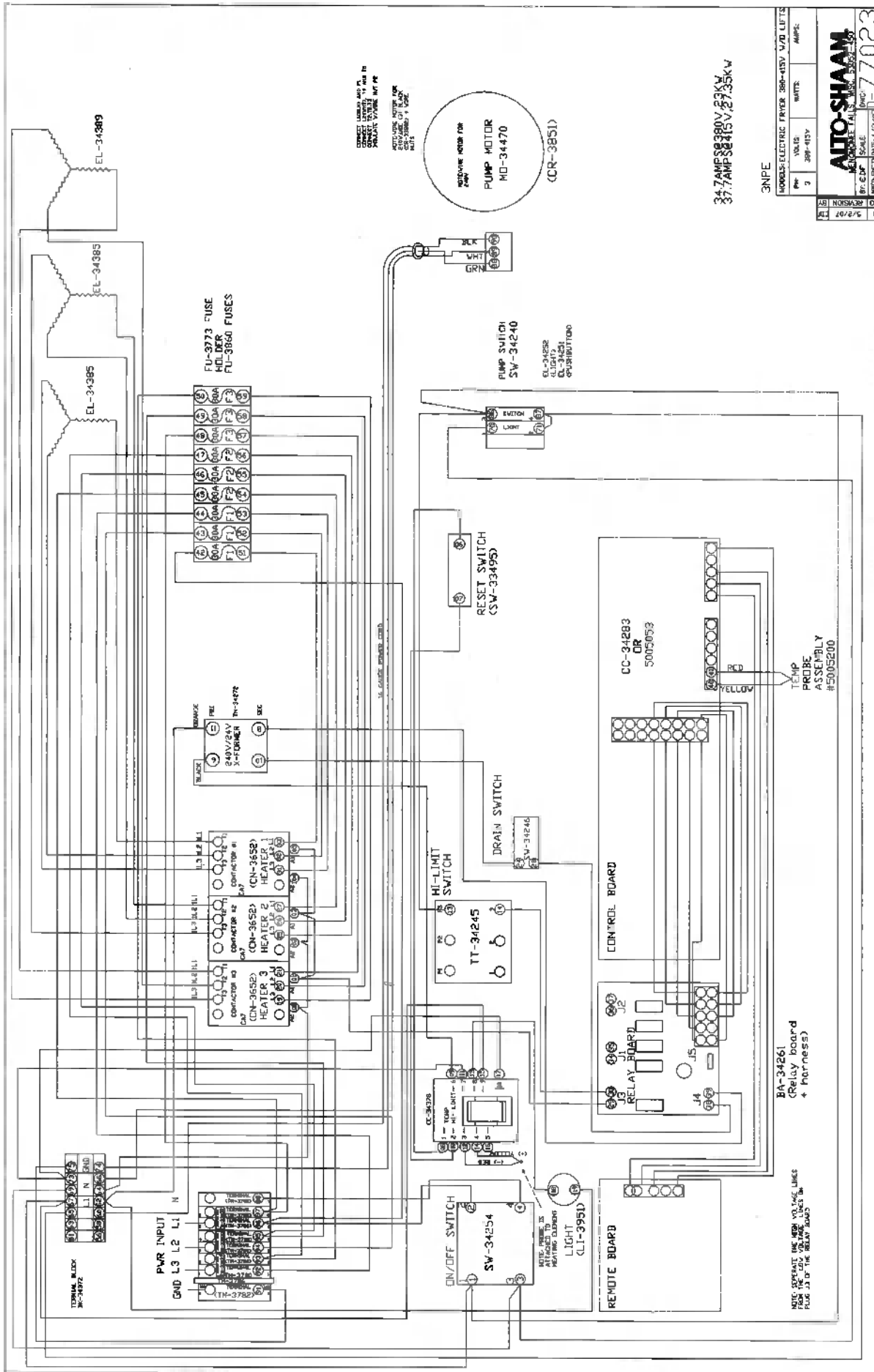

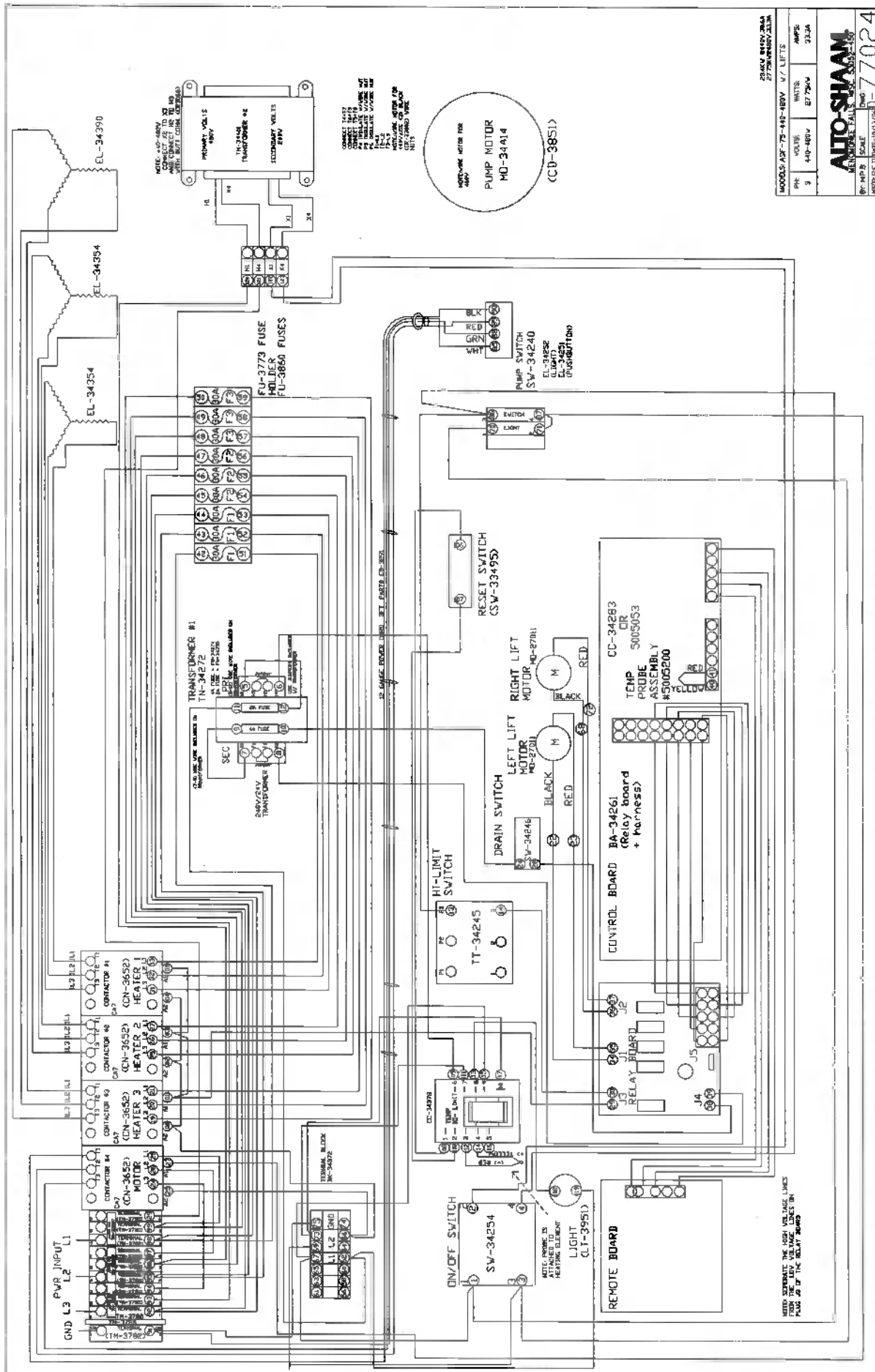

29-0414 04/01/2004
2775M/REV. 233A

MOODS	ASF-75	440-480V	M/LIFTS
PK	3	440-480V	AMP/2
PK	3	440-480V	AMP/2

AUTO-SHAAM
NEWARK, CALIF. 94568
SCALE: 1:1
APP'D: [Signature] DATE: 10/12/02 D-77024

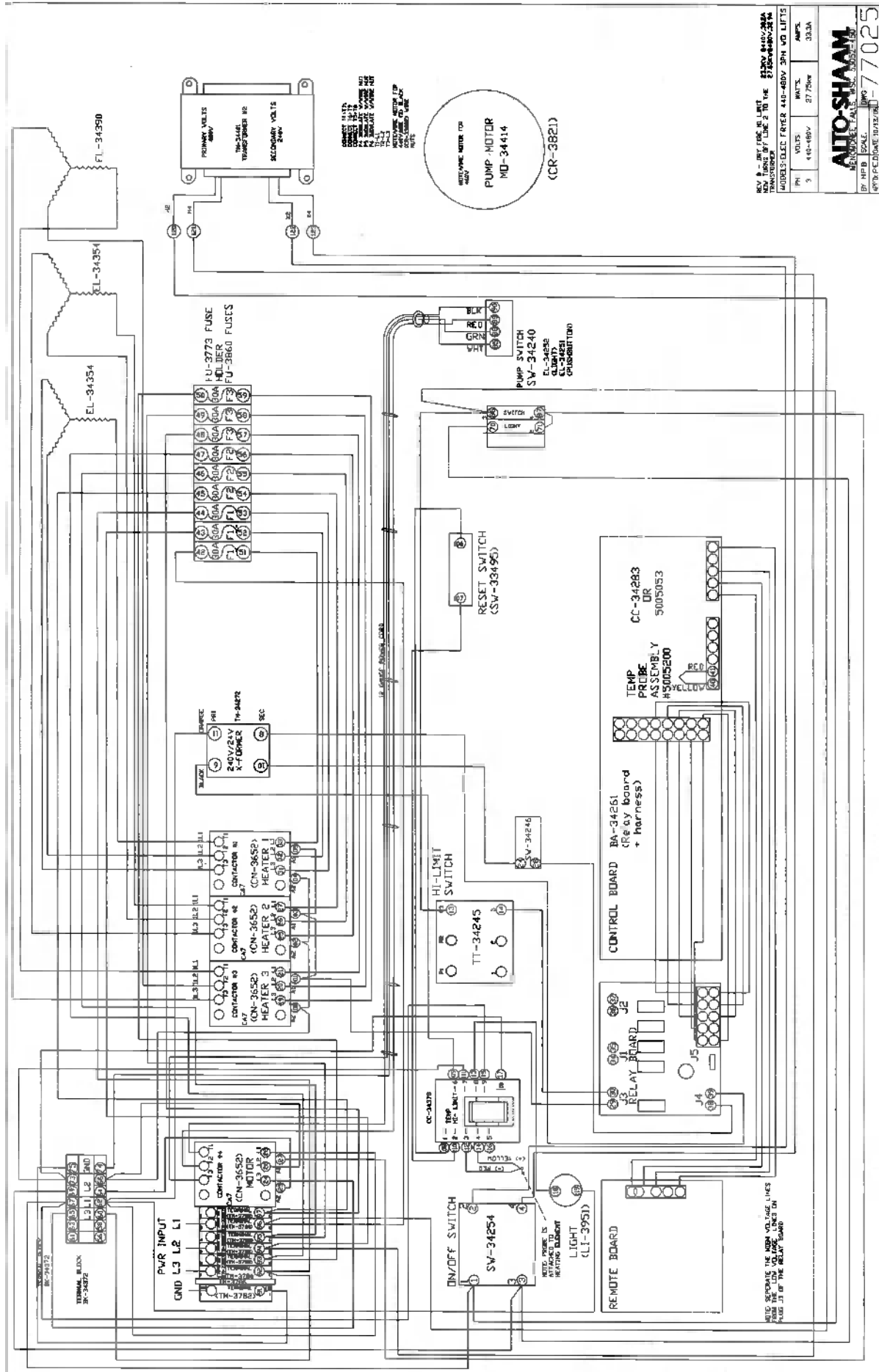

EXTENDED LIMITED FRYPOT WARRANTY

Alto-Shaam, Inc. warrants to the original purchaser that any frypot that is found to be defective in material or workmanship will, at Alto-Shaam's option, subject to provisions hereinafter stated, be replaced with a new or rebuilt frypot.

The labor warranty remains in effect for three (3) years from the shipping date. Alto-Shaam will bear shipping and normal labor charges for installation performed during standard business hours, and excluding overtime, holiday rates or any additional fees.

The parts warranty remains in effect for seven (7) years from the shipping date. Following the initial three (3) year labor warranty, Alto-Shaam will replace the frypot only, with freight, labor and all additional charges at the full responsibility of the owner/operator.

Extended frypot warranty coverage is subject to all remaining provisions as set forth in Alto-Shaam's standard published warranty.



TRANSPORTATION DAMAGE and CLAIMS

ALTO SHAAM. LIMITED WARRANTY



All Alto-Shaam equipment is sold F.O.B. shipping point, and when accepted by the carrier, such shipments become the property of the consignee.

Should damage occur in shipment, it is a matter between the carrier and the consignee. In such cases, the carrier is assumed to be responsible for the safe delivery of the merchandise, unless negligence can be established on the part of the shipper.

1. Make an immediate inspection while the equipment is still in the truck or immediately after it is moved to the receiving area. Do not wait until after the material is moved to a storage area.
2. Do not sign a delivery receipt or a freight bill until you have made a proper count and inspection of all merchandise received.
3. Note all damage to packages directly on the carrier's delivery receipt.
4. Make certain the driver signs this receipt. If he refuses to sign, make a notation of this refusal on the receipt.
5. If the driver refuses to allow inspection, write the following on the delivery receipt:
Driver refuses to allow inspection of containers for visible damage.
6. Telephone the carrier's office immediately upon finding damage, and request an inspection. Mail a written confirmation of the time, date, and the person called.
7. Save any packages and packing material for further inspection by the carrier.
8. Promptly file a written claim with the carrier and attach copies of all supporting paperwork.

We will continue our policy of assisting our customers in collecting claims which have been properly filed and actively pursued. We cannot, however, file any damage claims for you, assume the responsibility of any claims, or accept deductions in payment for such claims.

Alto-Shaam, Inc. warrants to the original purchaser that any original part that is found to be defective in material or workmanship will, at Alto-Shaam's option, subject to provisions hereinafter stated, be replaced with a new or rebuilt part.

The labor warranty remains in effect one (1) year from installation or fifteen (15) months from the shipping date, whichever occurs first. Alto-Shaam will bear normal labor charges performed during standard business hours, and excluding overtime, holiday rates or any additional fees.

The parts warranty remains in effect for one (1) year from installation or fifteen (15) months from the shipping date, whichever occurs first.

However, the heating element on Halo Heat® cook/hold ovens and the refrigeration compressor on Alto-Shaam QuickchillersSM are warranted for a period of five (5) years from installation. The labor warranty is the same as stated above; namely, for one (1) year from installation or fifteen (15) months from the shipping date, whichever occurs first.

THIS WARRANTY DOES NOT APPLY TO:

1. Calibration.
2. Replacement of light bulbs and/or the replacement of display case glass due to damage of any kind.
3. Equipment damage caused by accident, shipping, improper installation or alteration.
4. Equipment used under conditions of abuse, misuse, carelessness or abnormal conditions including, but not limited to, equipment subjected to harsh or inappropriate chemicals including, but not limited to, compounds containing chloride or quaternary salts, poor water quality, or equipment with missing or altered serial numbers.
5. Damage incurred as a direct result of poor water quality, inadequate maintenance of steam generators and/or surfaces affected by water quality. Water quality and required maintenance of steam generating equipment is the responsibility of the owner/operator.
6. Damage caused by use of any cleaning agent other than Alto-Shaam's Combitherm® Cleaner including, but not limited to, damage due to chlorine or other harmful chemicals. Use of Alto-Shaam's Combitherm® Cleaner on Combitherm® ovens is highly recommended.
7. Any losses or damage resulting from malfunction, including loss of product or consequential or incidental damages of any kind.
8. Equipment modified in any manner from original model, substitution of parts other than factory authorized parts, removal of any parts including legs, or addition of any parts.

This warranty is exclusive and is in lieu of all other warranties, expressed or implied, including the implied warranties of merchantability and fitness for a particular purpose. In no event shall Alto-Shaam be liable for loss of use, loss of revenue or profit, or loss of product, or for any indirect or consequential damages. No person except an officer of Alto-Shaam, Inc. is authorized to modify this warranty or to incur on behalf of Alto-Shaam any other obligation or liability in connection with Alto-Shaam equipment.

ALTO-SHAAM, INC.

RECORD THE MODEL AND SERIAL NUMBER OF THE APPLIANCE FOR EASY REFERENCE.
ALWAYS REFER TO BOTH MODEL AND SERIAL NUMBER IN ANY CONTACT WITH ALTO-SHAAM REGARDING THIS APPLIANCE.

Model: _____ Date Installed: _____
Voltage: _____ Purchased From: _____
Serial Number: _____

W164 N9221 Water Street • P.O. Box 450 • Menomonee Falls, Wisconsin 53052-0450 • U.S.A.

PHONE: 262.251.3800 • 800.558-8744 USA/CANADA

FAX: 262.251.7067 • 800.329.8744 U.S.A. ONLY

WEBSITE: www.alto-shaam.com

PRINTED IN U.S.A.